

NETIMPRESS *avant*

Flash Programmer

Start-up Manual

Revision History

Edition	Date of Issue	Description
1st edition	14th Mar,2019	Initial publication
2nd edition	29th Nov, 2019	Fixing errors
3rd edition	15th Feb, 2022.	Chapter 11. YCM File is added
4th edition	6th Jan, 2023	Fixing errors
5th edition	6th June, 2025	Modify for WEB site renewal

- (1) No part of this manual may be reproduced or transmitted in any form or by any means, electronic or mechanical, without the written permission of DTS INSIGHT Corporation.
- (2) The contents of this manual are subject to change without prior notice due to improvement of the functionality.
- (3) If any question about the contents of this manual arises, contact Support center of DTS INSIGHT Corporation or your local distributor.
- (4) DTS INSIGHT Corporation shall not be held responsible for direct or indirect adverse effects resulting from operation of this system irrespective of the above item (3).
- (5) Trademarks, logos, and symbol mark, mentioned in this manual, are registered trademarks of DTS INSIGHT Corporation.

INTRODUCTION

NETIMPRESS avant Start-up Manual, (hereinafter “this manual”) describes basic steps from installing software to starting a programming.

Read this manual carefully before configuring the programming environment by using NETIMPRESS avant.

Display screen images of Windows 10 environment are used in this manual. Display screen image and operating procedures may vary if you are using other environment.

 The wording “Programming” in this manual means writing data into a target microcomputer flash memory or an external flash memory connected to the target microcomputer.

Meaning of Icons

The following table describes the meaning of icons used in this manual.



It indicates very important information. Extra care should be taken when operating NETIMPRESS avant.



It indicates useful information and tips for operation.



It indicates references. Please see the referenced chapter of this manual and other manuals, if you needed.

Contents

Revision History	1
INTRODUCTION	2
Meaning of Icons	2
1. OVERVIEW AND FEATURES	5
1.1. Overview of NETIMPRESS avant series	5
1.2. Communication environments	6
1.3. How to Start Programming	7
2. CHECK THE HARDWARE/SOFTWARE COMPONENT (FOR BASIC CONFIGURATION).....	8
2.1. Hardware	8
2.2. Software	8
3. SETTING UP THE SOFTWARE.....	10
3.1. Installing the software	10
3.1.1. How to install SWX600 (Remote Controller)	11
3.1.2. Installing AZ481 (Key file generator).....	14
3.2. Setting up Ethernet Connection	17
3.2.1. Setting up IP address to Programmer Main Unit.....	17
3.2.2. Connection to PC (SWX600: Remote Controller Setting).....	19
3.2.3. Confirmation points of Ethernet Connection Error	21
4. SETTING UP THE PROGRAMMING ENVIRONMENT.....	22
4.1. Adding definition license.....	22
4.1.1. How to acquire the license file.....	22
4.1.2. Adding definition license into dedicated SD card	27
4.2. Adding probe logic license	29
4.3. Creating YIM folder.....	30
4.4. Downloading each setting file.....	32
4.4.1. Downloading definition program.....	33
4.4.2. Downloading a parameter file.....	34
4.4.3. Downloading bundle files	35
4.4.4. Setting Parameters.....	36
4.4.5. Downloading object file to be programmed.....	37
4.5. Connecting to Target System.....	39
5. PROGRAMMING	41
5.1. Programming Procedure	41
6. SCREEN OF SWX600(REMOTE CONTROLLER).....	43

6.1. Basic Operation (Device Function screen).....	44
6.2. Parameter Table 1 (Parameter Setting Screen).....	45
6.3. File Transfer (File Transfer Screen).....	46
7. YIM FOLDER.....	47
7.1. YIM Folder Structure	47
7.2. Managing the programming environment.....	48
7.2.1. How to save YIM folder (Operation for the original folder).....	48
7.2.2. How to load YIM folder (Operation for the destination SD card).....	49
8. KEY FILE.....	50
8.1. Creating KEY file	51
9. CHECK THE SUM VALUE IN THE BUFFER OF YSM FILE	53
9.1. YSM file	53
9.2. Creating YSM file.....	53
10. EXT KEYS & CSB FILE	55
10.1.1. CSB File format.....	55
10.1.2. Example of Creating CBS File	58
11. YCM FILE	59
11.1. YCM File Format	59
11.2. Creating YCM file	61
11.3. How to use YCM file.....	62
12. GLOSSARY	63

1. Overview and Features

This chapter describes the overview of NETIMPRESS avant series, composition of the programming environment, and necessary operating procedures for starting the programming.

1.1. Overview of NETIMPRESS avant series

NETIMPRESS avant is an in-circuit programmer that performs high-speed on-board programming of a microcomputer with built-in flash ROM or flash ROM connected to external bus of a microcomputer.

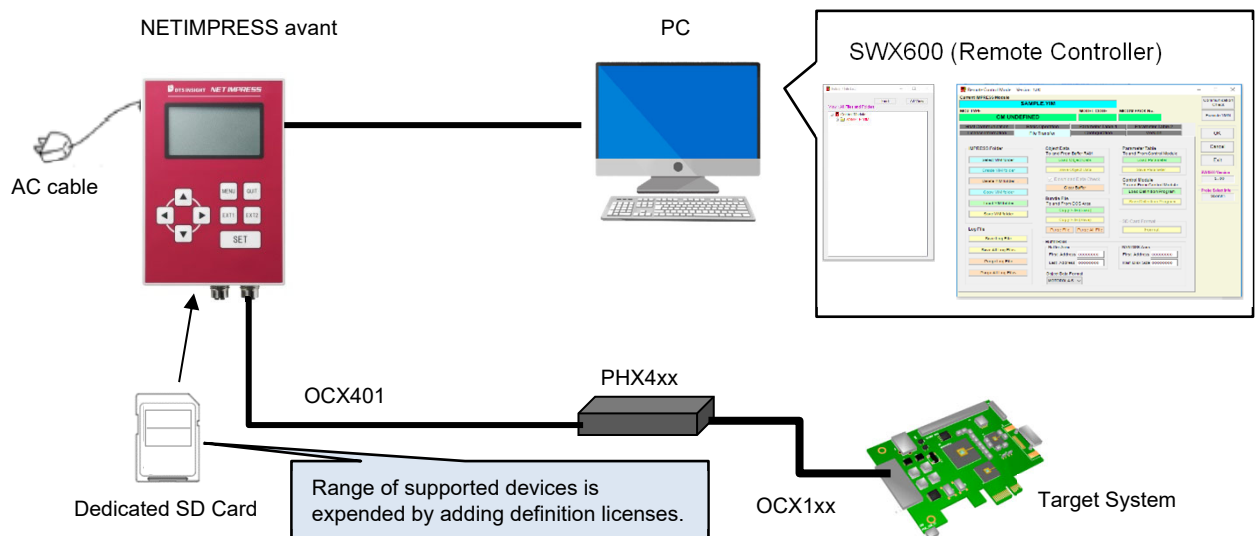

Various devices are supported by inserting dedicated SD card, which contains programming firm data for each microcomputer hereby called as “definition program”, into the programmer main unit. Range of supported devices can be expended by adding programming condition as a license to the SD card.

The programmer has the 1000BASE-T interface, therefore it is possible to set up programming conditions and control the programmer by SWX600 (Remote Controller software) on host PC.

Programming conditions saved in the SD card enable stand-alone operation without PC.

An automatically-controlled production line system can be constructed by using SWX610 (Remote Controller software).

Dedicated SD card	<ul style="list-style-type: none">● SD card is to contain programming firmware data for microcomputer. Programming for each device can be supported by inserting the SD card into the programmer.● Range of programmed devices is expanded by adding a definition license.● SD card is empty with definition licenses. Please make sure to add a definition license before operation.<ul style="list-style-type: none">➔ For how to add a definition license, see Chapter4.1“Adding definition license”.● If definition license supports microcontrollers of same series, a different microcontroller can be supported by changing micom pack provided by DTS INSIGHT.<ul style="list-style-type: none">➔ For more details about micom pack, see Chapter 4.4 “Downloading each setting file”.
-------------------	--



Make sure to use dedicated SD card provided by DTS INSIGHT. If you used other SD cards, it might result in failure.

1.2. Communication environments

Ethernet standard TCP/IP is used for communication between a host PC and NETIMPRESS avant. Appropriate interface on the host PC is necessary. If there are no interfaces on the host PC, please build additional interfaces.

(The terminal on the programmer is governed by and construed under standards of 10BASE-T /100BASE-TX/1000BASE-T)

1.3. How to Start Programming

This chapter describes basic steps from installing software to starting a programming.

For more detailed setting procedure, see each referenced manual.

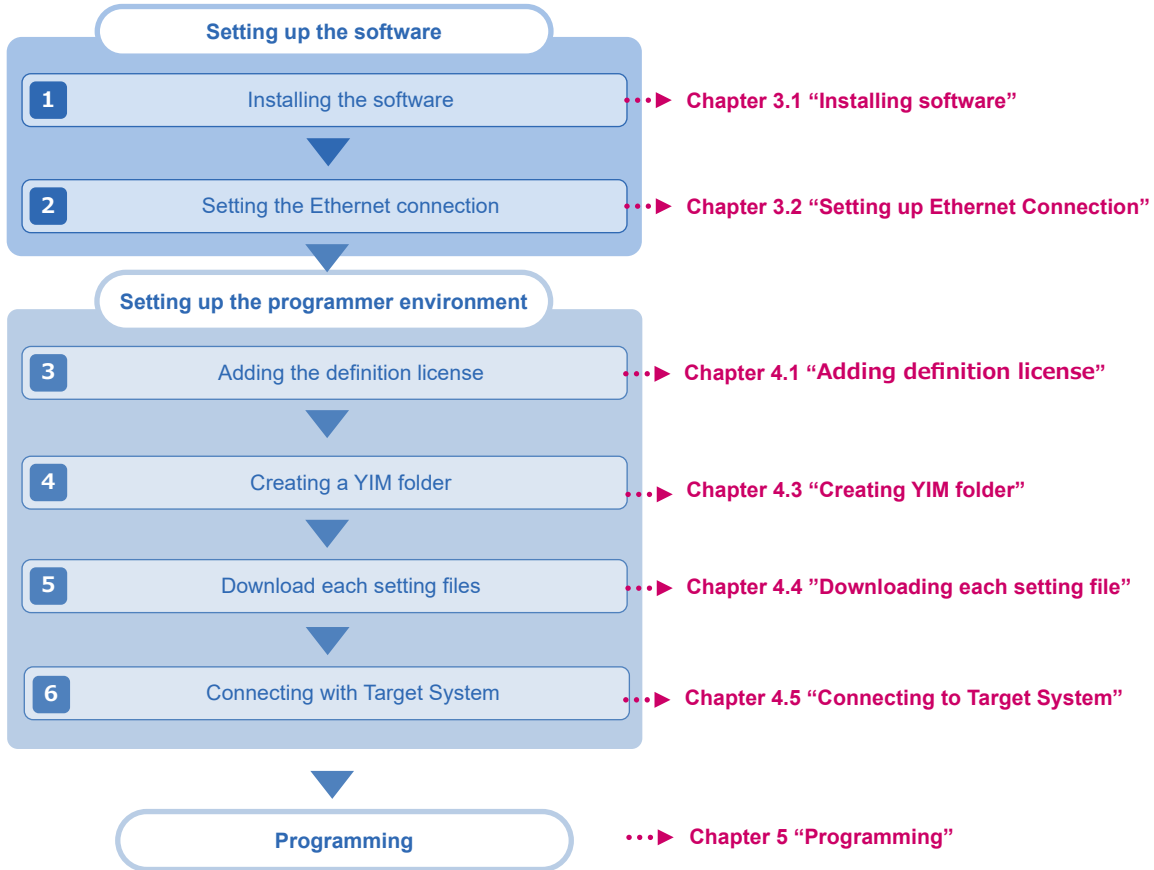

2. Check the Hardware/Software component (For Basic configuration)

2.1. Hardware

- NETIMPRESS avant main unit (Model name: AFX100)
- Dedicated AC code
- Dedicated SD card (model name: AFM700)
- Probe cable (model code: PHX400 or PHX410)

It depends on a target system environment.

- Host PC

Windows OS(Windows7 32bit · 64bit / Windows 10 32bit · 64bit) are run.

- Ethernet cable



Make sure to use dedicated AC cable sold separately by DTS INSIGHT.

2.2. Software

- SWX600 (Remote Controller)

It is used for downloading files, executing device functions, and setting parameters.

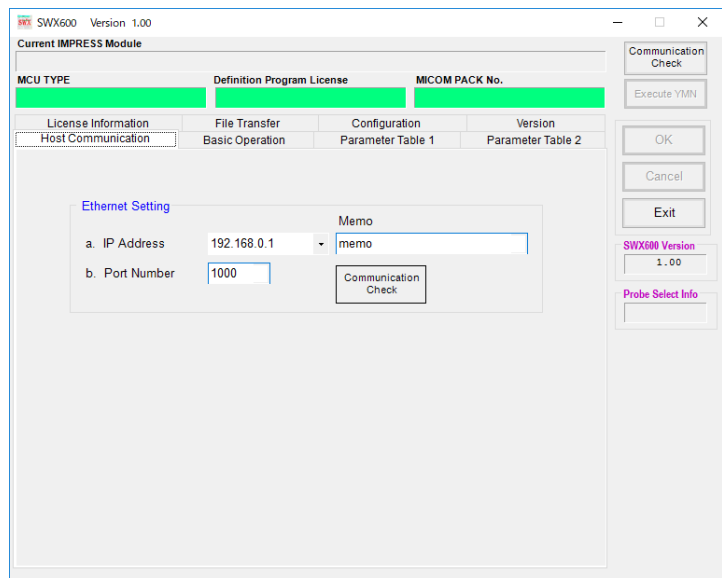
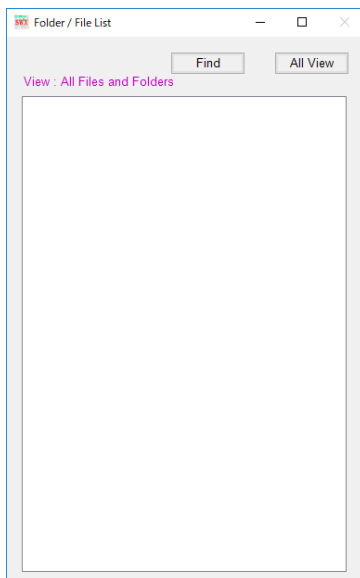

- AZ481 (KEY file generator)
it is used for generating a KEY file (file for checking the security of device), and creating a YSM file (file for checking SUM value of object).

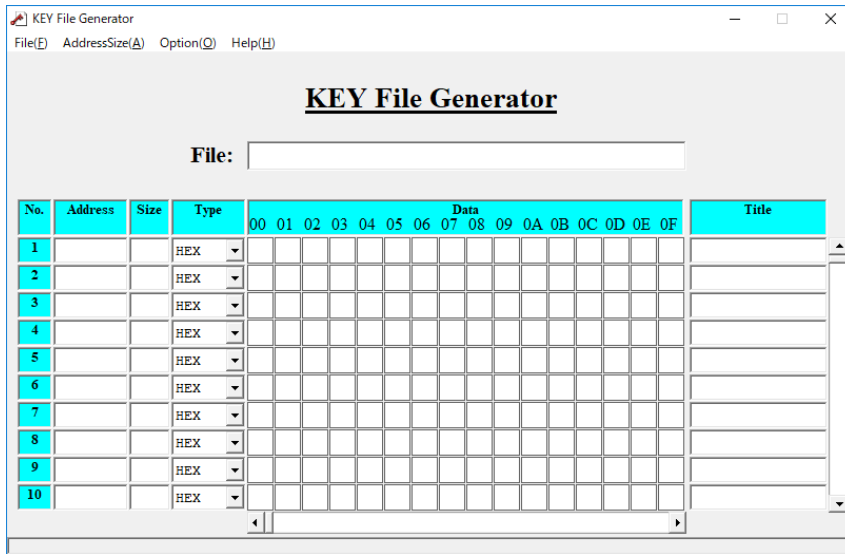

3. Setting up the Software

3.1. Installing the software

The following software are used for configuring the programming environment.

- SWX600 (Remote controller)
- AZ481 (KEY file generator)

Software is available on our home page.

Download them from the link below.

https://support.dts-insight.co.jp/en/product/support_netimpress/download/

The screenshot shows the 'NETIMPRESS Support' website. The page title is 'NETIMPRESS Support' and the sub-page is 'Download'. There is a search bar with the text 'Search by keyword' and a 'Search' button. Below the search bar, there are filters for 'Category' (Software for PC, Manual / Startup Guide) and 'Product series' (NETIMPRESS avant / acorde, NETIMPRESS next / G-NETIMPRESS, NETIMPRESS air). The 'Software for PC' section includes a note: 'User and product registration is required to download documents marked with [lock icon]'. Below this is a table with columns: Product series, MODEL, Rev, Files for Download, DATE, and Notes.

Product series	MODEL	Rev	Files for Download	DATE	Notes
NETIMPRESS avant / acorde	SWX600	1.32	SWX600_132_64bit.zip	2024/02/29	Remote Control Software (Windows 7/10/11 64bit)
NETIMPRESS avant / acorde	SWX600	1.32	SWX600_132_32bit.zip	2024/02/29	Remote Control Software (Windows7/10 32bit)
NETIMPRESS avant / acorde	SWX680	1.05	SWX680_105.zip	2020/04/16	IP Address setting tool for NETIMPRESS acorde
NETIMPRESS avant / acorde	AZ481	2.20	az481_220.zip	2017/03/30	KEY File Generator
NETIMPRESS avant / acorde	AZ486	1.02	az486_102.zip	2017/05/24	YBO File Generator



In this manual, SWX600(Ver.1.00) is used. Display screen image may vary if other version is used.

The software is ZIP file. Install the software after extracting it in a folder on host PC. After the completion of installation, an icon is created on the Windows [Start] menu – <All programs> - <DTS INSIGHT Tools>.

➔ For more details about supported OS and other installation conditions for each software, refer to “SWX600 Software Manual” (SWX600mnEnn.pdf) and “Instruction manual of AZ481 Key file generator file creation tool” (AZ481mnEnn.pdf). (*nn* stands for a revision of manual.)

3.1.1. How to install SWX600 (Remote Controller)

(1) Double-click the downloaded installer (SWX600_ *nnn*_64bit.zip) (*nnn* varies depending on the version) to extract installation.

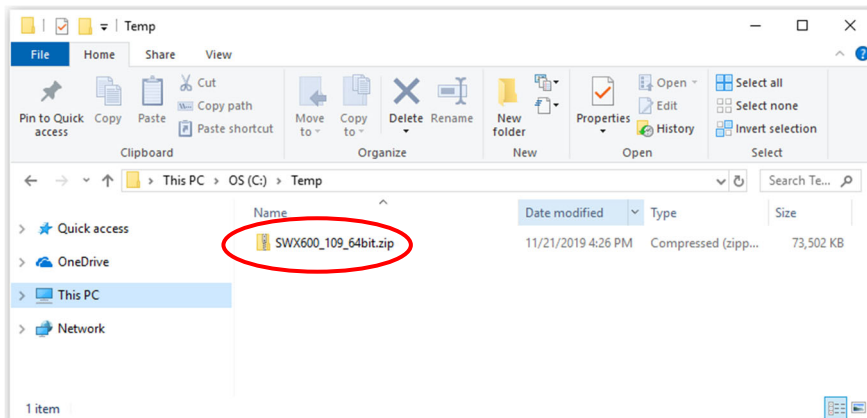

(2) Double-click the downloaded installer (setup.exe) to start installation.

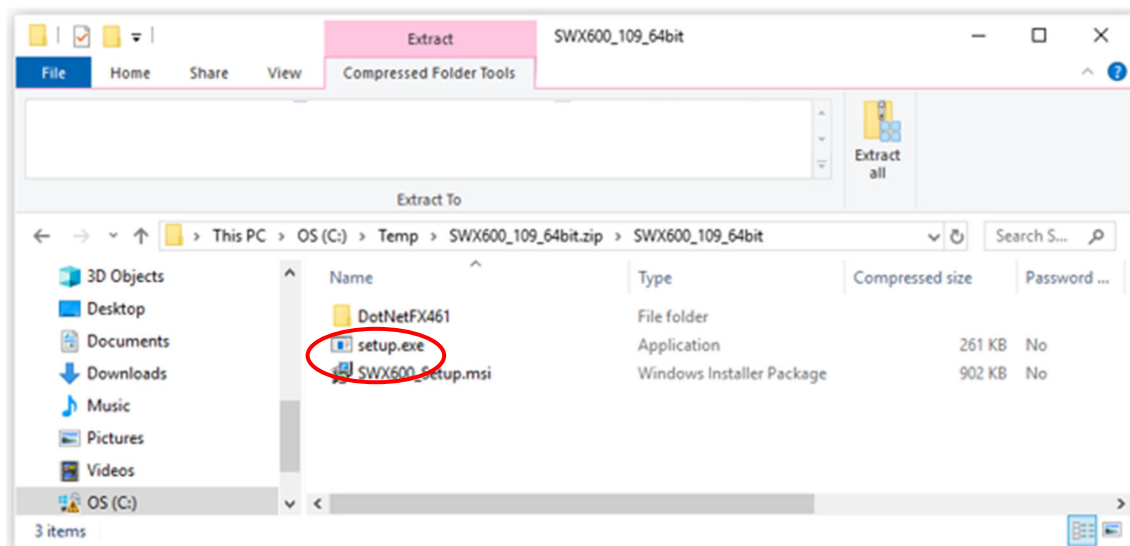

! The installation has not finished yet as of this step. Follow the steps below to install the software.

(3) Follow the installer's direction to install SWX600(Remote Controller).

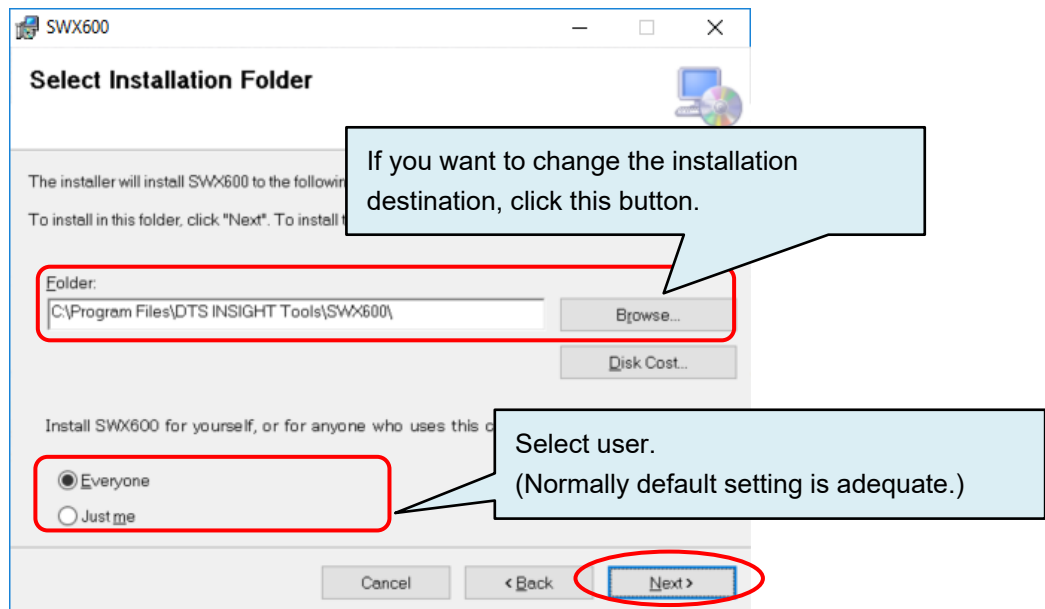
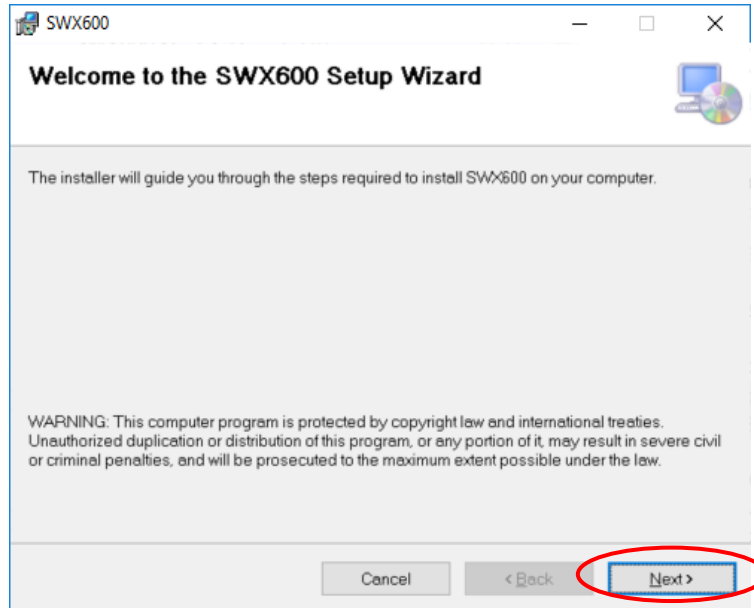

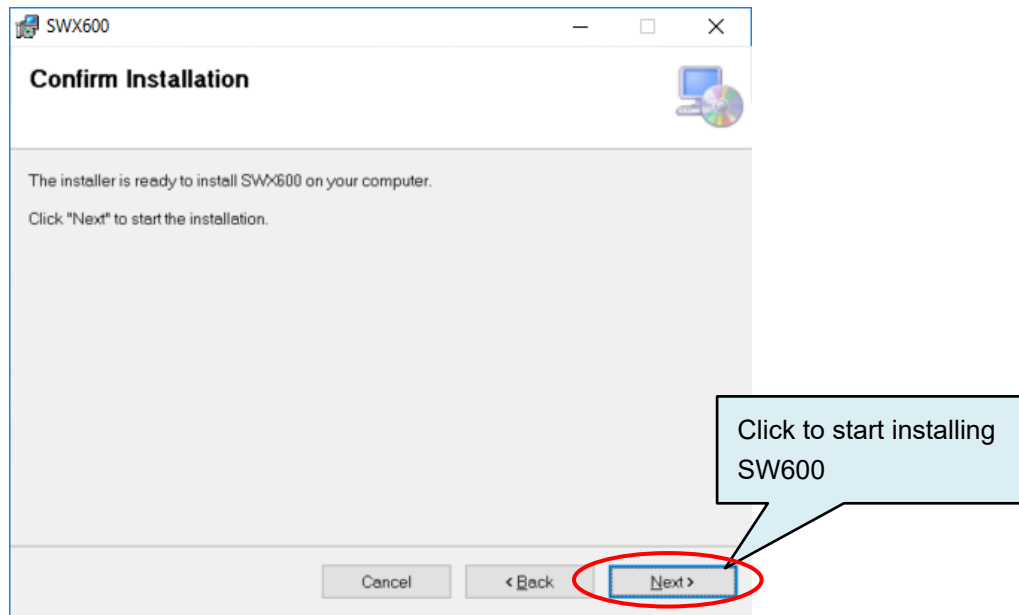

(4) The install has finished when the following dialog appears.

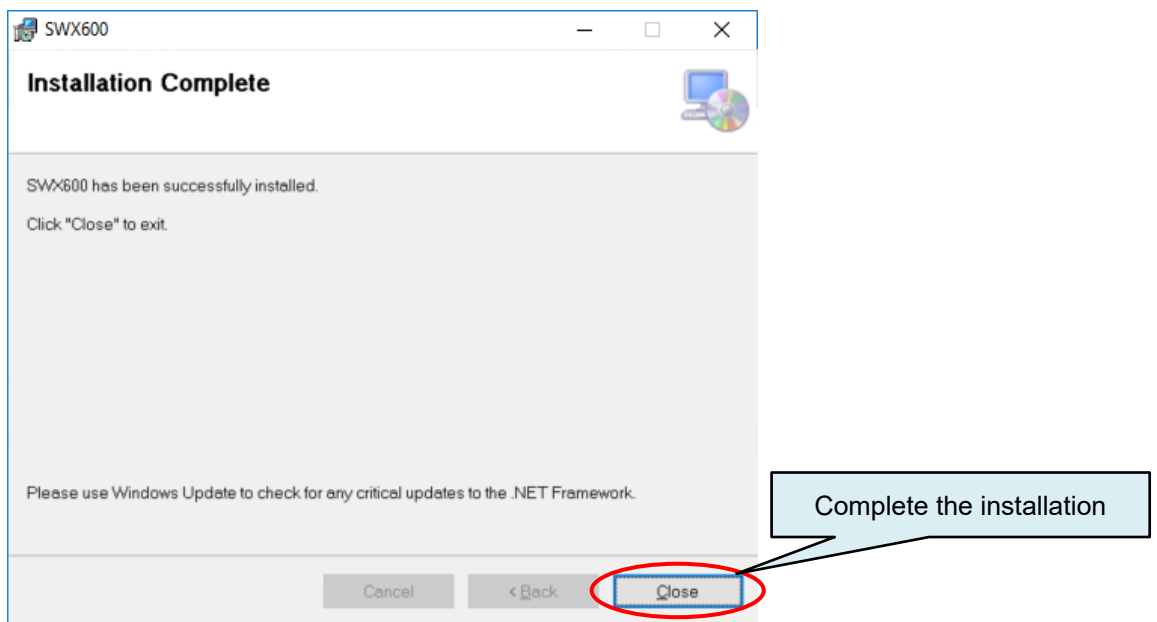

3.1.2. Installing AZ481 (Key file generator)

(1) Download AZ481 (KEY file generator) from our website.

https://support.dts-insight.co.jp/en/product/support_netimpress/download/

Software for PC					
🔗 User and product registration is required to download documents marked with 🔑.					
Product series	MODEL	Rev	Files for Download	DATE	Notes
NETIMPRESS avant / acorde	SWX600	1.32	SWX600_132_64bit.zip ↓	2024/02/29	Remote Control Software (Windows 7/10/11 64bit)
NETIMPRESS avant / acorde	SWX600	1.32	SWX600_132_32bit.zip ↓	2024/02/29	Remote Control Software (Windows7/10 32bit)
NETIMPRESS avant / acorde	SWX680	1.05	SWX680_105.zip ↓	2020/04/16	IP Address setting tool for NETIMPRESS acorde
NETIMPRESS avant / acorde	AZ481	2.20	az481_220.zip ↓	2017/03/30	KEY File Generator

(2) Extract downloaded ZIP file (az481_nnn.zip) (nnn varies depending on the version).

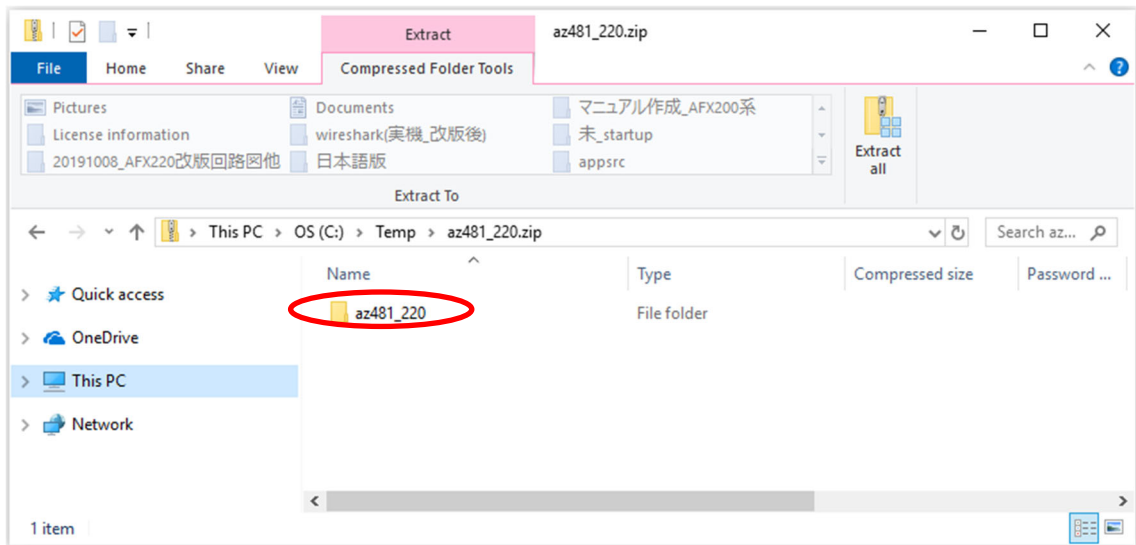

(3) Open the extracted folder and double-click the installer (setup.exe) to start the installation.

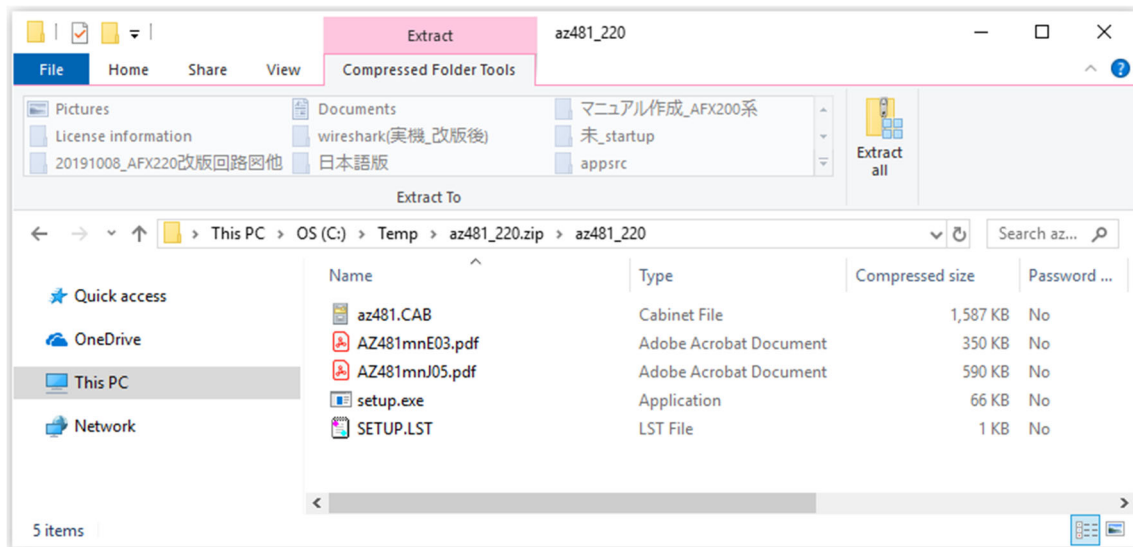

The installation has not finished yet as of this step. Follow the steps below to install the software.

(4) Install AZ481 (Key file generator) by following the instruction of installer

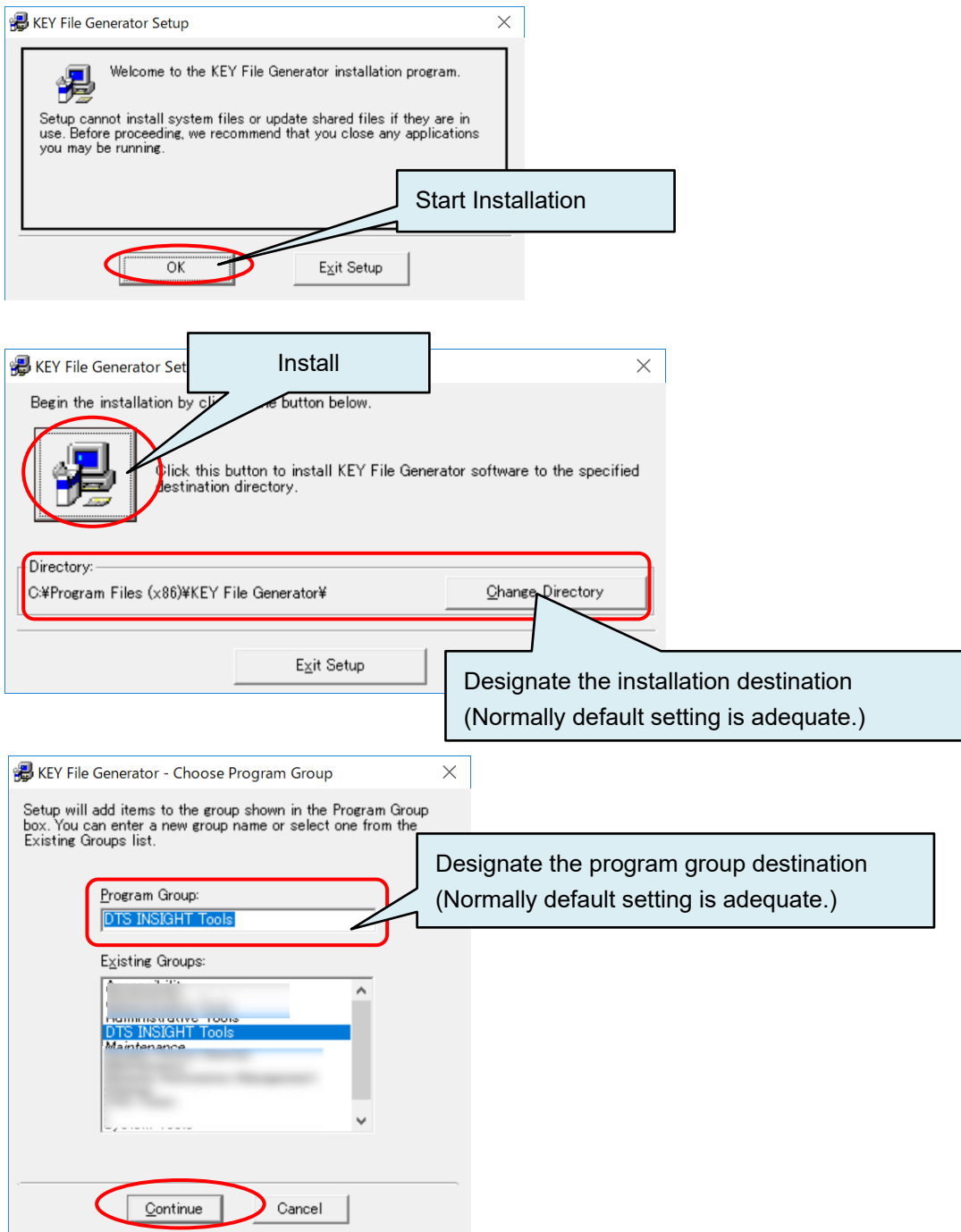

(5) Installation is completed when the following dialog box is displayed.

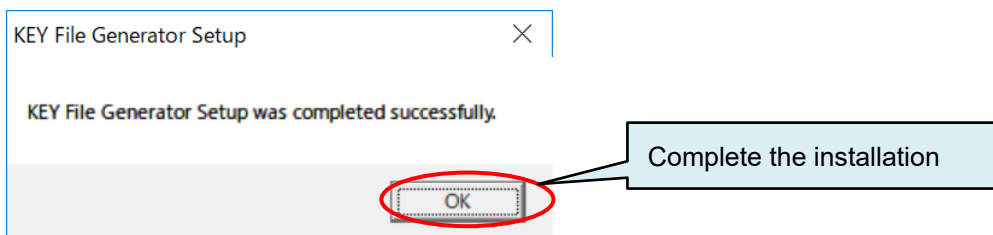

3.2. Setting up Ethernet Connection

3.2.1. Setting up IP address to Programmer Main Unit

Set up an IP address to the programmer main unit in order to control it via Ethernet by a PC.

* If incorrect key is pressed, press “QUIT” key once and then set up from (2) again.



NETIMPRESS avant does not support DHCP. Assign fixed IP address.

- (1) Power on the programmer after insert dedicated SD card to the programmer main unit and connect dedicated AC code.





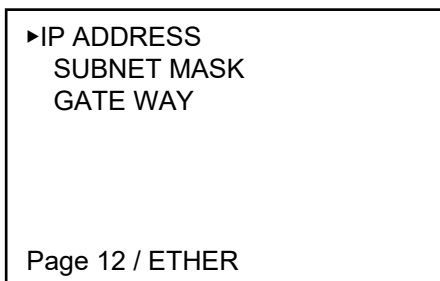

Please make sure that the SD card is correctly inserted after powering it off, if “initialize SD CARD INIT /ETHER INIT” keep appearing on LCD of the programmer after powering it on. IP address cannot be set if dedicated SD card is not inserted.

- (2) Follow the steps below to press the keys on the programmer.

Press **MENU** once ⇒ Press **◀** twice ⇒ Select “IP ADDRESS” by pressing **▲** and **▼** ⇒ Press **SET**



(3) Enter IP address and port number to be set the Programmer by pressing , , , .

IP ADDRESS 192.168. 0. 2
PORT 1000 h
QUIT:Back SET:Exec ▼▲:Change ◀▶:Cursor

(4) Press **SET** to execute IP address setting.



Do not overlap the programmer's IP address with host PC or device connected to the same network.

3.2.2. Connection to PC (SWX600: Remote Controller Setting)

Follow the steps below to set up environments to control NETIMPRESS avant by the Remote Controller AZ490.

- (1) Connect host PC and the programmer by Ethernet cable (10BASE-T, 100BASE-TX/1000BASE-T)
- (2) Start SWX600 (Remote Controller) by host PC.
[Start] menu – <All programs> - <DTS INSIGHT Tools>
- (3) Enter IP address and port number which are set the programmer on “Host Communication” tab.
Click “**Communication Check**” button after entering them.

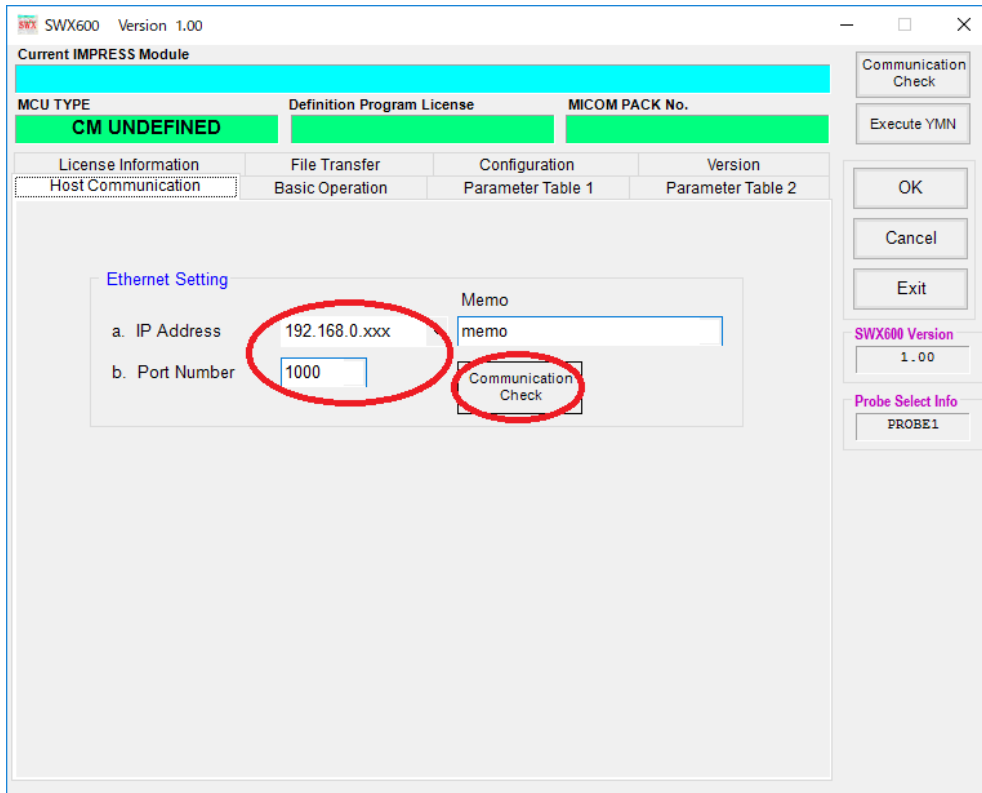

- (4) The communication between host PC and the programmer is established, and the programmer is controlled by host PC.

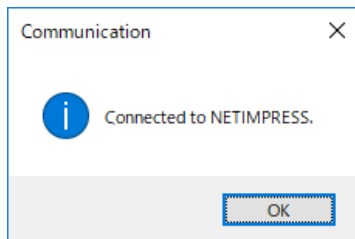

If the following dialog window appears due to communication error, the communication between PC and the programmer is not established. Make sure the status of connection and Ethernet setting.

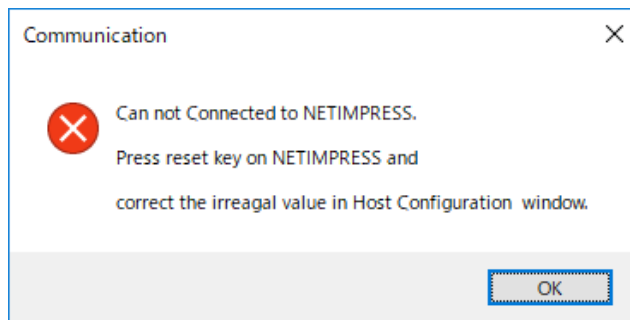

3.2.3. Confirmation points of Ethernet Connection Error

<p>Is Ethernet cable correctly connected to both of host PC and the programmer?</p>	<ul style="list-style-type: none"> ● Make sure Ethernet cable is connected to connectors of host PC and the programmer. Make sure the cable is connected to Ethernet hub as well if Ethernet hub is used.
<p>Is IP address set correctly?</p>	<ul style="list-style-type: none"> ● Make sure IP address of the programmer is correctly entered. ➡ Refer to "3.2.1. Setting up IP address to Programmer Main Unit" of this manual. ● Make sure the programmer's IP address does not overlap with host PC's or any other devices'. ● If host PC's IP address is automatically assigned (DHCP), NETIMPRESS avant cannot be connected. Certainly set IP address. ● Configure correct IP addresses of host PC and NETIMPRESS avant according to subnet mask setting. If subnet mask is 255.255.255.0, high 24 bits should be same value of host PC and NETIMPRESS avant.
<p>Is port number set correctly?</p>	<ul style="list-style-type: none"> ● Make sure the programmer's port number is correctly entered. If the number has not to be set, enter default value "1000", ➡ Refer to "3.2.1. Setting up IP address to Programmer Main Unit" of this manual.
<p>Subnet mask</p>	<ul style="list-style-type: none"> ● The default subnet mask value of the programmer is "255.255.255.0". The subnet mask should be same as host PC. ➡ If any changes are necessary, refer to "2.12.2. SUBNET MASK" of "NETIMPRESS avant OPERATION MANUAL" (NETIMPRESS_avant_stand-alone_smenn.pdf).

4. Setting up the programming environment

4.1. Adding definition license

A definition license for each definition program has to be added into dedicated SD card in order to use a definition program for a target MCU.

This license file (.LCT file) can be downloaded if you register your information on our website by referring to the license sheet provided when you purchased the definition program.

Definition license file	<ul style="list-style-type: none"> ● The file name of probe logic license is "licence model name_serial number_SD serial number.LCT" e.g. FCX839-S2_U191Y1234NL_UAB12345FS.LCT ● The license file can be downloaded if you register your information on our website. https://support.dts-insight.co.jp/en/ (the License file is sent by e-mail after the registration.)
-------------------------	---

4.1.1. How to acquire the license file

(1) Prepare a License sheet and dedicated SD card in hand.

The blue frame below will be necessary information for Product registration.

License Sheet

NETIMPRESS avant/acorde license sheet / NETIMPRESS avant/acorde ライセンスシート

NETIMPRESS *avant*
NETIMPRESS *acorde*

NETIMPRESS avant/acorde Software Authorization

2019/01/15

MODEL	FRX803
CONTENTS	License for Programmer
SIN	U191Y0007NL
Check Code	123

This license sheet is required for when issuing a license and asking for the technical support. We will not resuse this sheet for whatever reason. Please keep this at hand.
本紙は、ライセンス発行とテクニカルサポートを受ける際の必要となります。いかなる理由においても再発行は差し上げませんので大切に保管してください。

株式会社 DTS インサイト
DTS INSIGHT CORPORATION

No. ABC0002-123

Dedicated SD Card



(2) Access product support website, log in and proceed to My Page.

(If you have not yet registered as a user, please register as a new user and then log in.)

URL: <https://support.dts-insight.co.jp/en/>

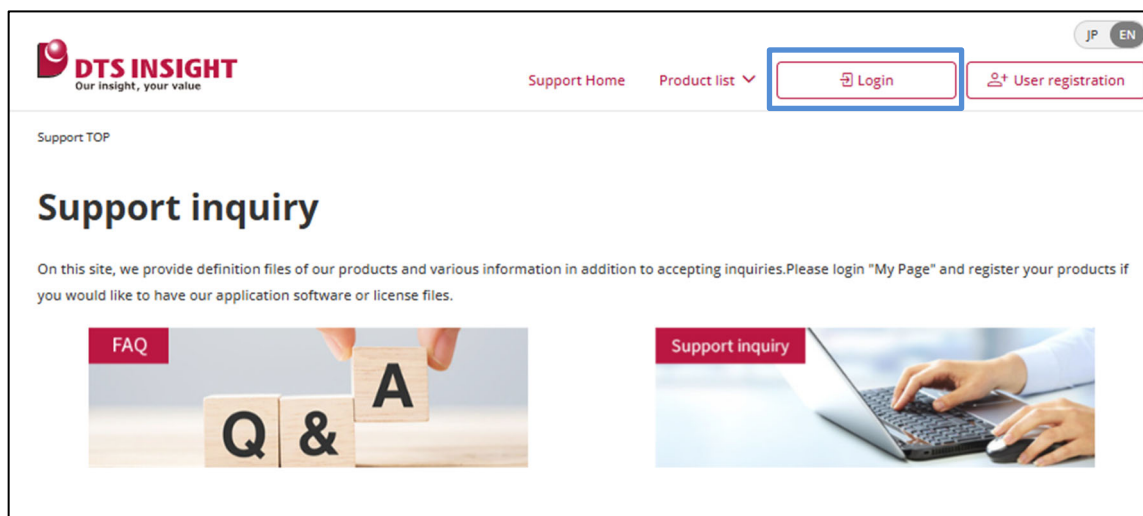

(3) Click the "Product registration / License issuance" button on your My Page (if you are registering only one product) or the "Bulk product registration / Bulk license issuance" button (if you are registering multiple products at once) to proceed to the product registration form.

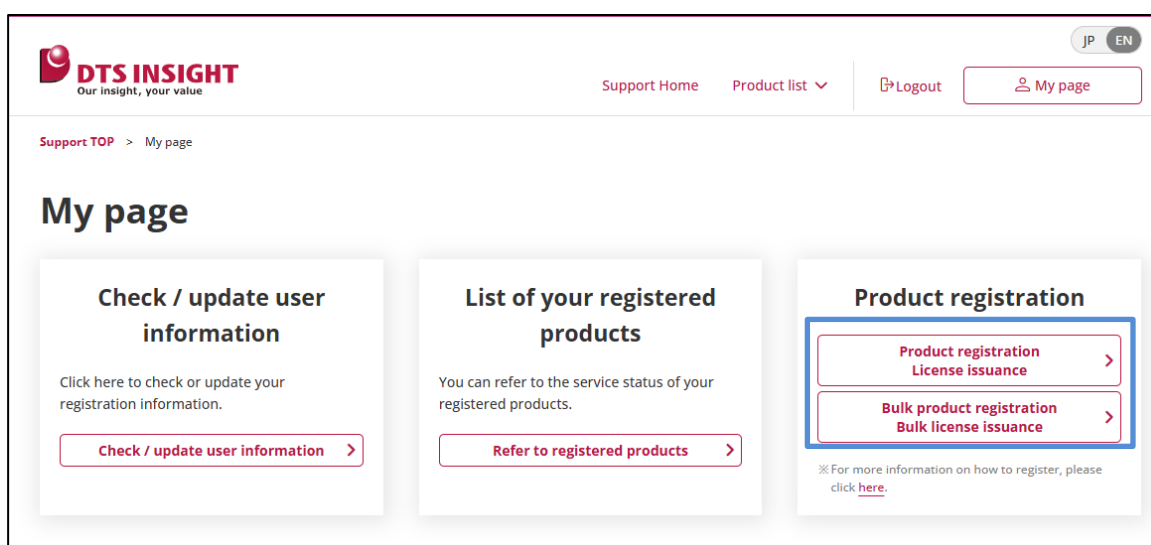

(4) Enter information on the license sheet (Model, S/N, and Check Code), serial No. of SD card, on the Product Registration page, and press the "confirm" button. Confirm that there is no mistake in the confirmation screen display content, and register product.

The screenshot shows the 'Product registration / License issuance' page. At the top, there is a navigation bar with 'Support Home', 'Product list', 'Logout', and 'My page'. Below the navigation bar, the breadcrumb trail reads 'Support TOP > My page > Product registration > Product registration / License issuance'. The main heading is 'Product registration / License issuance'. The form contains a 'MODEL' field with the value 'e.g., S2X600/N'. A callout box points to this field with the text 'Enter description of MODEL field on License sheet'. Below the field, there is a note: '※ Please enter the MODEL of the software license printed on the license sheet. For hardware products, enter the MODEL number printed on the product label.' At the bottom of the form is a red 'Proceed to registration form' button.

The screenshot shows the 'Product registration / License issuance' page at the 'Confirm' step. The breadcrumb trail is 'Support TOP > My page > Product registration > Product registration/License issuance entry'. The main heading is 'Product registration / License issuance'. Below the heading, it says 'Please click on "Confirm" after entering the following items.' A progress indicator shows three steps: 'STEP 1 Input' (completed), 'STEP 2 Confirm' (current), and 'STEP 3 Completed'. The form contains several fields: 'Product category 1' (NETIMPRESS), 'Product category 2' (NETIMPRESS avant / acorde), 'MODEL' (FCX839-S2), 'Serial No.(S/N)' (required, e.g. U123P4567NL or ABC12345XX, with a note 'Please enter the software license S/N printed on the license sheet.'), 'Serial number of SD card' (required, e.g. XXX12345FC or XXX12345FS, with a note 'Please enter the S/N of dedicated SD card to which the license is applicable.'), and 'Check code' (required, e.g. 123). A red 'Confirm' button is at the bottom. Callout boxes provide instructions: 'Enter description of S/N field on License sheet' points to the Serial No.(S/N) field, 'Enter serial number of dedicated SD card applicable License' points to the Serial number of SD card field, and 'Enter description of check code field on License sheet' points to the Check code field.

Please complete form above, and click "Confirm" button.

Bulk registration using CSV file is useful when multiple licenses need to be registered.

- Sample of a CSV file for batch registration with a text editor

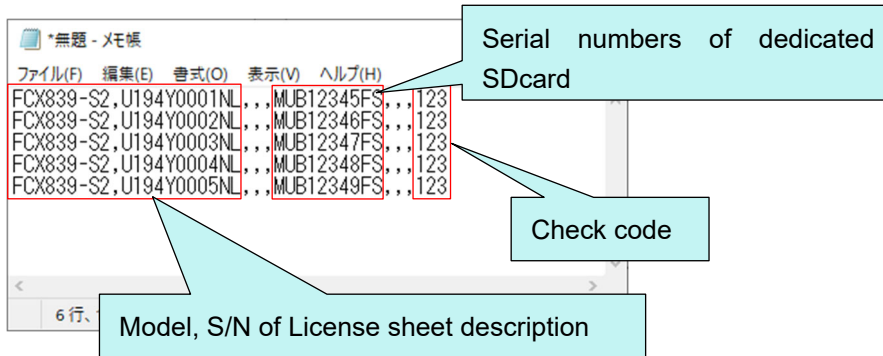

- Format of the CSV file for bulk registration. (Multiple product categories can be mixed in the CSV file.)

Product Category	Format
NETIMPRESS main unit	Product model,Serial Number,,,,,
Programmer license	Product model,Serial Number,,, SD Card Serial number,,,Check code
Micom Pack	Product model,Serial Number,,,,, Check code
Probe logic license	Product model,Serial Number,,,,,NETIMPRESS main unit Serial number,, Check code
PC software	Product model,Serial Number,,,,, Check code

*Please pay attention to the position and number of commas.

- How to specify a CSV file on the products registration page

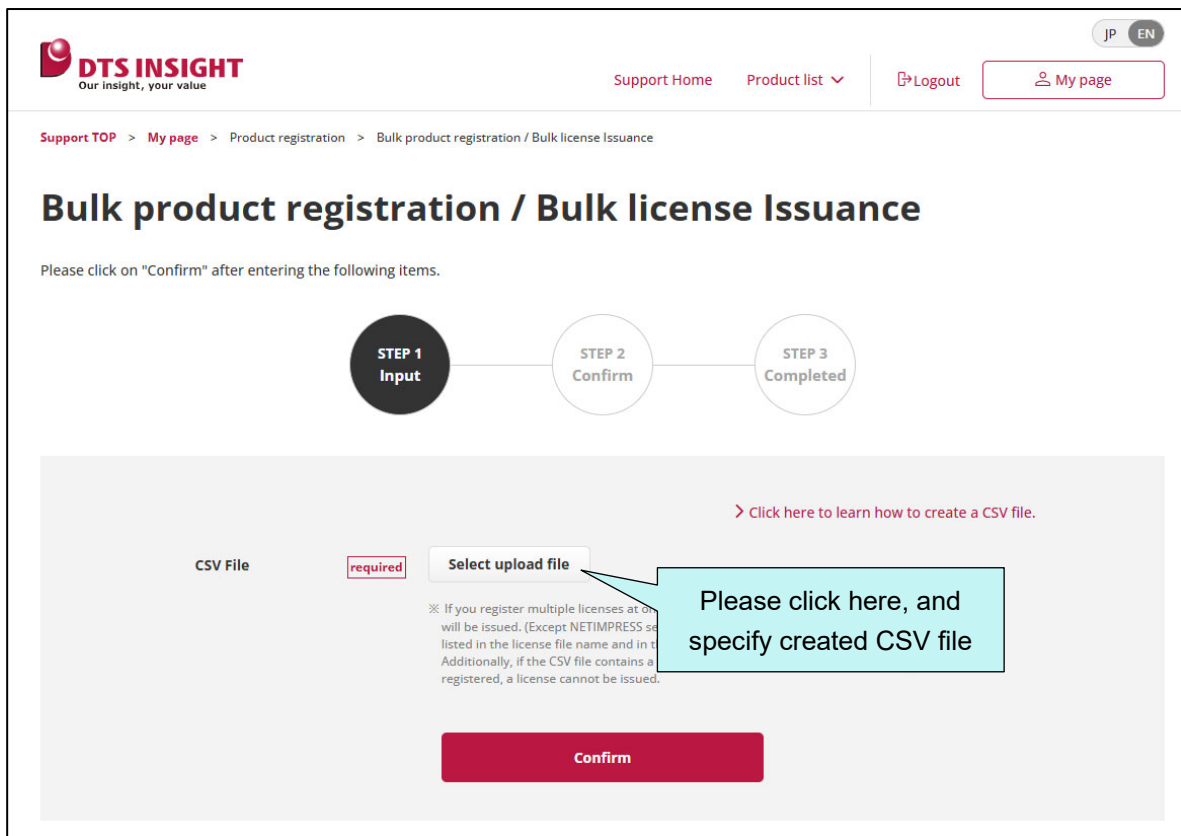

(5)The registration has been completed, an e-mail attached license file is sent.

From: **DTS INSIGHT Customer Support** <web_server@dts-insight.co.jp>
Date: 2025年xx月xx日(Mon) 10:10
Subject: Product / License registration completed
To: <xxxxxxxx@dts-insight.co.jp>

Thank you for registering our products. It has been completed.

If you registered the software products which needs license file,
the license files are attached on this mail as well.

If license information for multiple products is combined into one file,
the file name will only contain the representative product model
number and serial number.

|

■ Product and Serial No.

[Product] : NETIMPRESS avant / acorde

[Model] : FCX839-S2

[Serial No.] : U194Y0001NL

This email is for sending only. We can't respond if you reply to this email.

DTS INSIGHT Customer Support

4.1.2. Adding definition license into dedicated SD card

- (1) Save license file (.LCT) to a local folder of host PC.
- (2) Start SWX600 (remote controller) and connect NETIMPRESS avant.
- (3) Click “License Information” tab and open a window for selecting license file by “Add License” button.

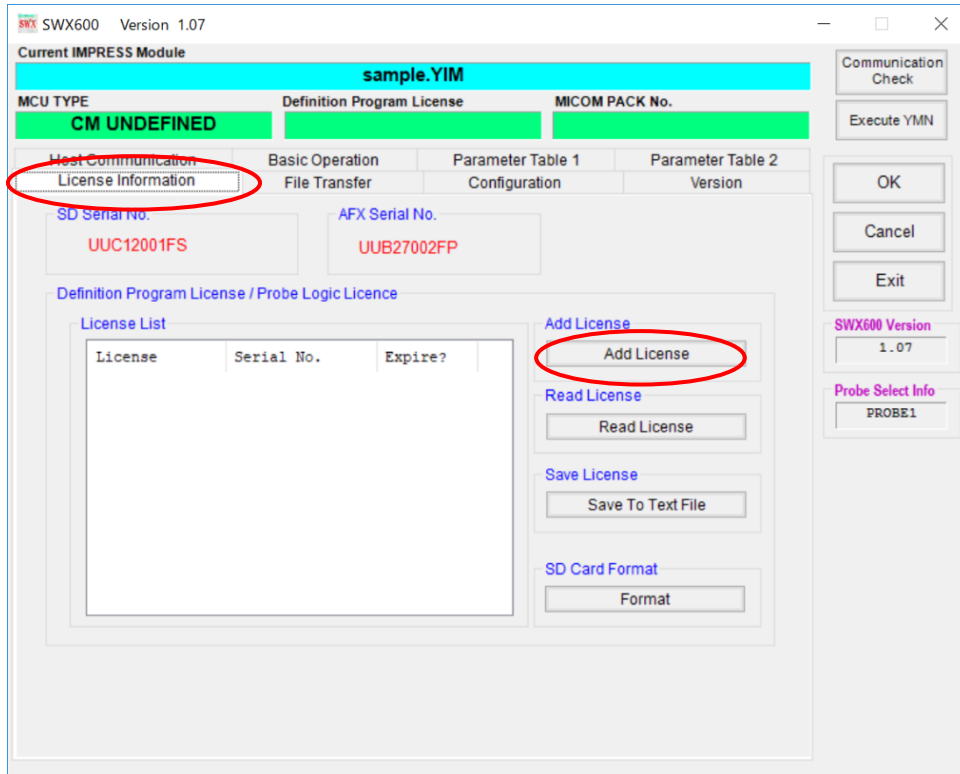

- (4) Select license file which is prepared in (1).

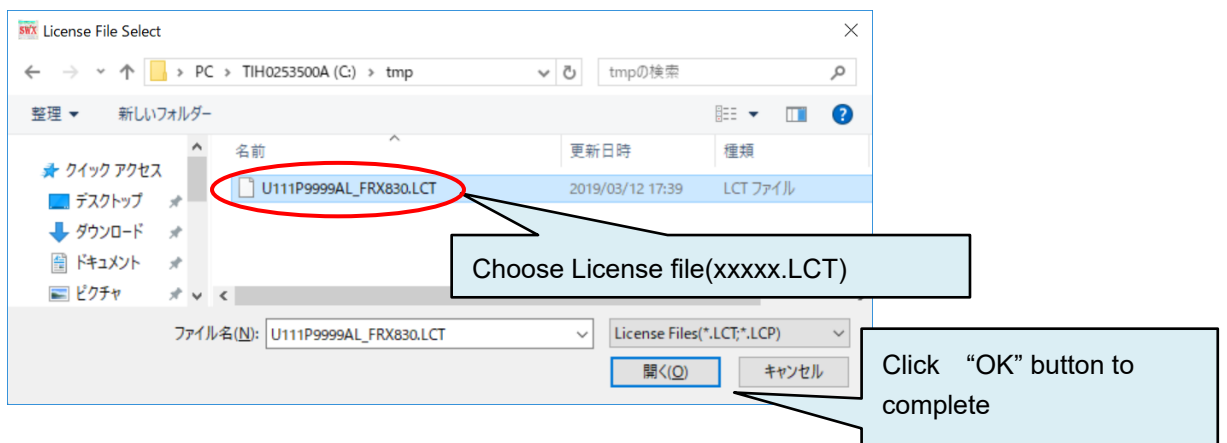

- (5) Confirmation dialog opened by clicking “Load License File and Add License” button.
License is added to dedicated SD card by clicking “OK” button.

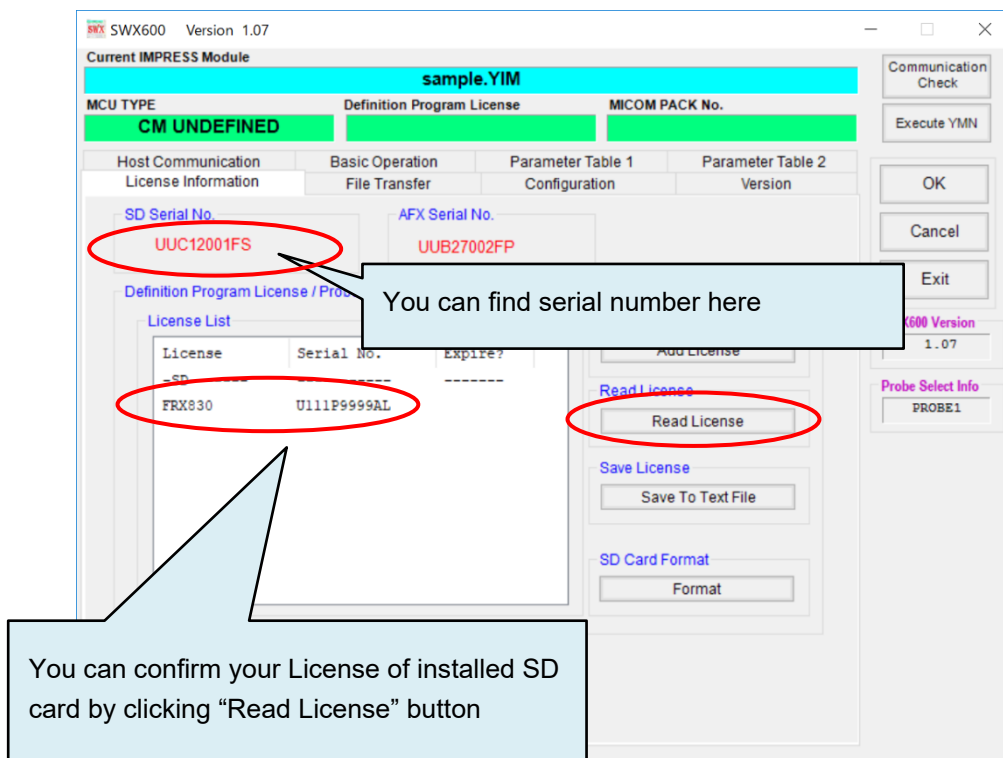
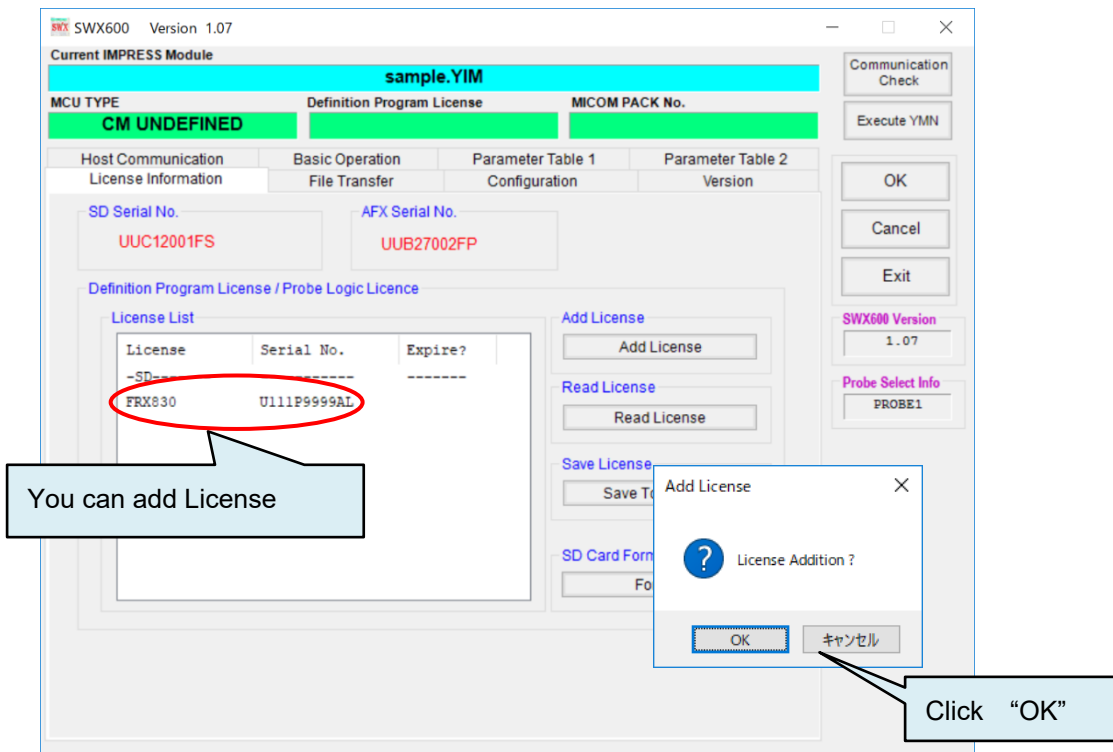

- ✓ Serial number of SD card and added definition licenses can be confirmed by stand-alone operation with keys on the programmer.

- Showing added licenses: **MENU** → P.8 → “READ LICENSE”
- Showing serial number of inserted SD card: **MENU** → P.8 → SERIAL NUMBER

4.2. Adding probe logic license

PHX400 and PHX410 are available as probe cable for NETIMPRESS avant. PHX is a multiple interface cable which support various interface. It supports serial and SPI in default, and supported interfaces are expanded by adding probe logic license to NETIMPRESS avant.

PHX410 supports CAN and CAN-FD.

Adding probe logic license is same as “4.1. Adding definition license

”

License file	<ul style="list-style-type: none">● Extension of probe logic license is LCP● The file name of probe logic license is “license model_serial number_AFX serial number.LCP” e.g.PLX420_U191U1234NL_KAB12345FP.LCP● The license file can be downloaded if you register your information on our website. https://support.dts-insight.co.jp/en/ (The license file is sent by e-mail after the registration.)
--------------	--

4.3. Creating YIM folder

Setting of programmed object and programming environment is saved as YIM folder (extension .YIM) in dedicated SD card.

After definition license is added, configure programming environment by creating YIM folder.

YIM folder	<ul style="list-style-type: none"> ● Extension of YIM folder is .YIM. ● Programming environment of the SD card is saved as a YIM folder. More than one environment can be saved in the SD card and environment can be switched by selecting YIM folder.
------------	---

➔ For more details about YIM folder, refer to “7. YIM folder.”

- (1) Select “AFM700” in “Folder / File List” window of SWX600 (remote controller).
- (2) Select “File Transfer” tab and click “Create YIM Folder” button. A window for naming a YIM folder appears. Enter YIM folder name and then click “OK” button.

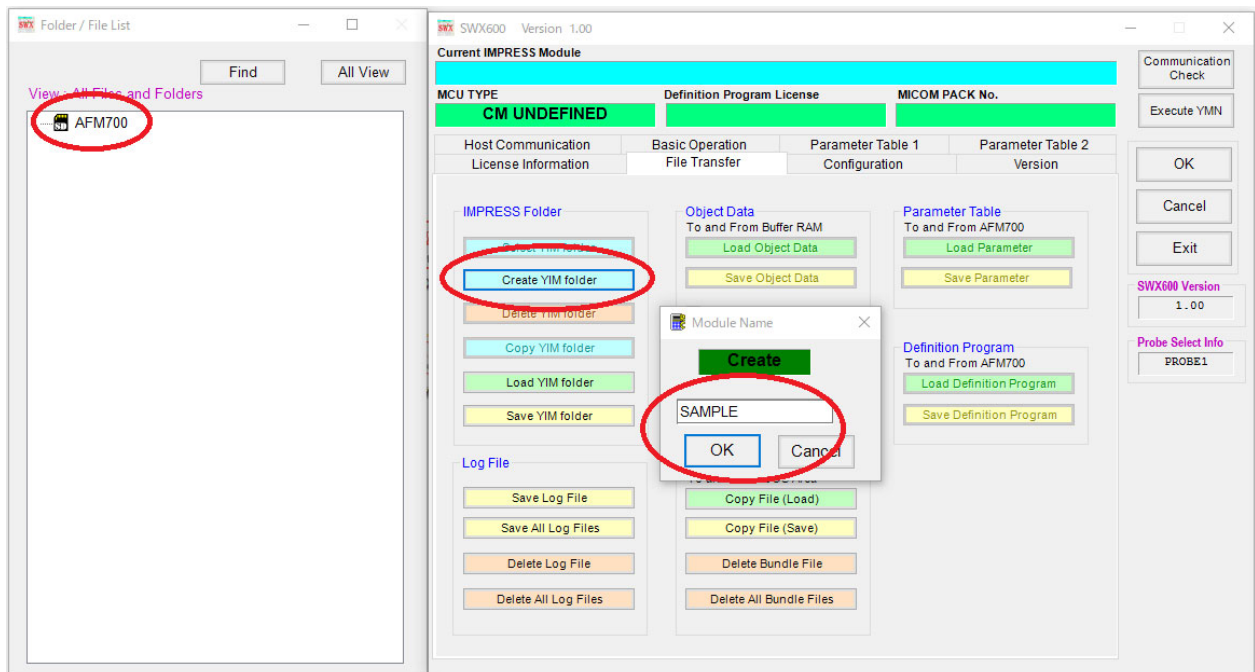

✓ YIM folder is also created by right-click on Folder / File List window and selecting “Create” button.

- (3) Created YIM folder is listed in “Folder / File List” window.
 Select the YIM folder, click “Select YIM folder” in the main window.
 A window appears and asks YIM folder. Select YIM folder and click “Select” button.

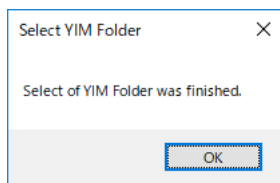
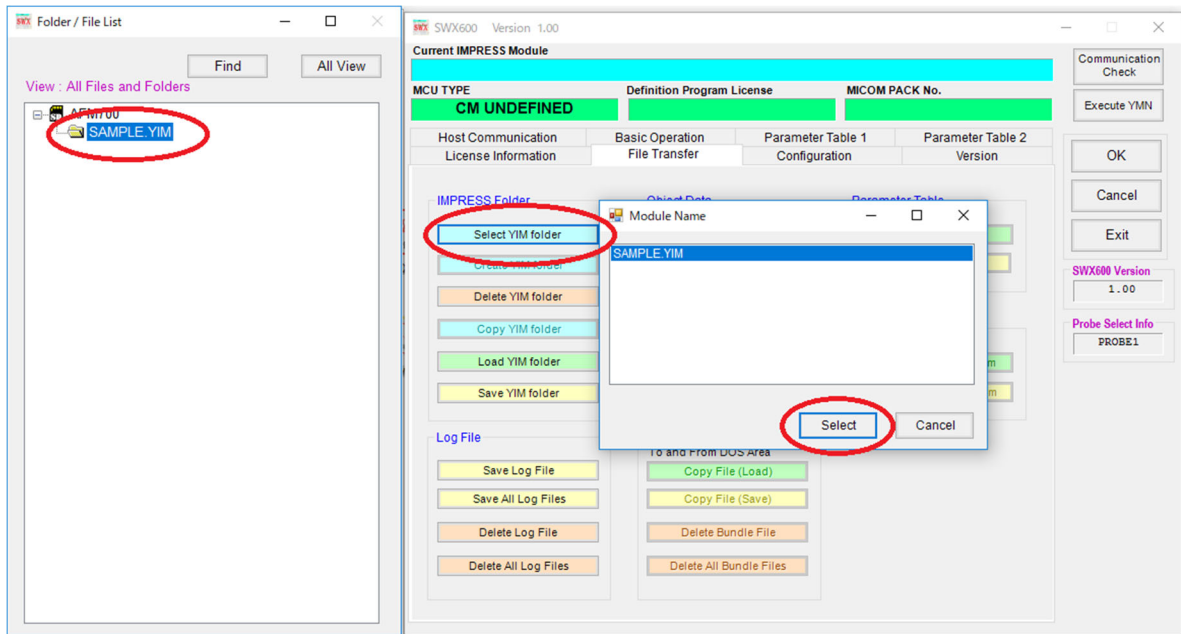

- ✓ YIM folder is also selected by double-clicking YIM folder in “Folder / File List” window.

- (4) Selected YIM folder in (3) is set as current folder, and name of the YIM folder is shown on the top of main window of SWX600 (remote controller).

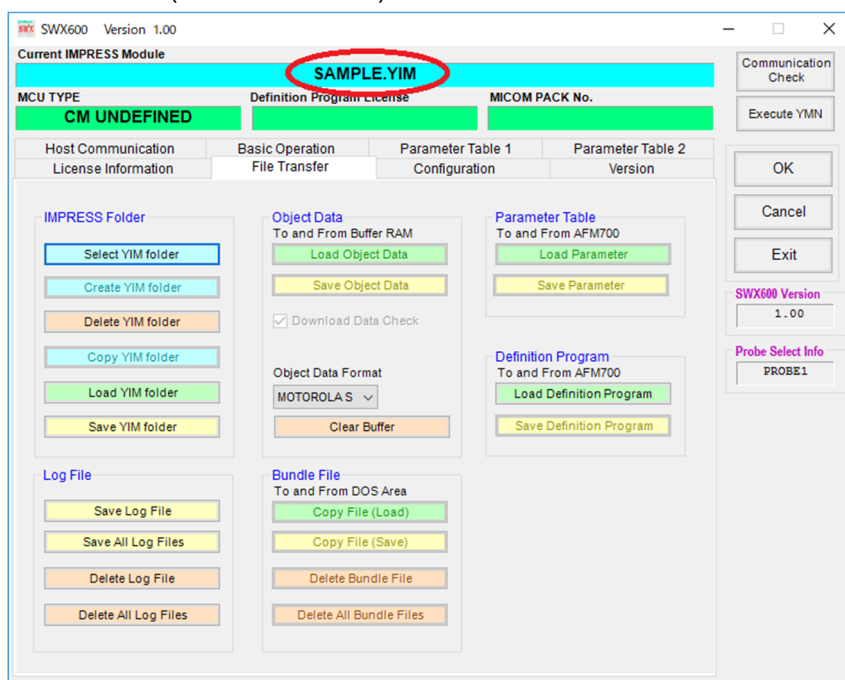

Current folder	<ul style="list-style-type: none">● When loading files is executed, the files are downloaded to this YIM folder.● When device functions are executed, programming environment is in this YIM folder.
----------------	---

4.4. Downloading each setting file

Files for setting programming environment are downloaded to current folder.

Prepare definition program (extension .CM) and files of micom pack. Micom pack is downloaded from our web site.

https://support.dts-insight.co.jp/en/product/support_netimpress/micom/

<https://support.dts-insight.co.jp/en/mypage/usages/>

Micom pack	<ul style="list-style-type: none">● Files for setting programming environment. Each supported device has micom pack for it.● Download it from our website.● Downloaded micom pack is a compressed file (ZIP format). Extract the file by double-clicking it.● Micom pack includes several files, such as parameter file (extension .PRM), manual, writing control program (extension .BTP), and readme file. (Contents differ depending on device.)
------------	--

4.4.1. Downloading definition program

Definition Program is downloaded by clicking “Load Definition Program” in “Definition Program” group of “File Transfer” tab.

Definition Program

- Extension is .CM.
- It can be downloaded from our website.

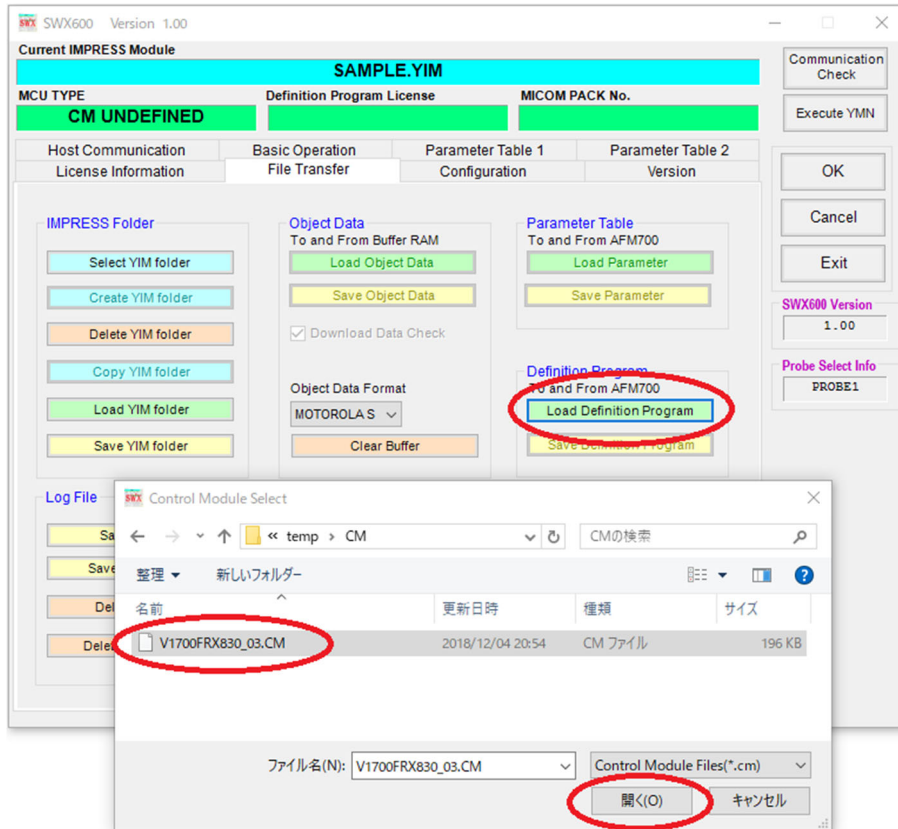

4.4.2. Downloading a parameter file

Parameter file is downloaded by clicking “Load Parameter” button in “Parameter Table” group of “File transfer” tab.

Parameter File	<ul style="list-style-type: none"> ● Extension is .PRM. ● It is included in micom pack. ● It is a parameter table file including device information of target system.
----------------	--

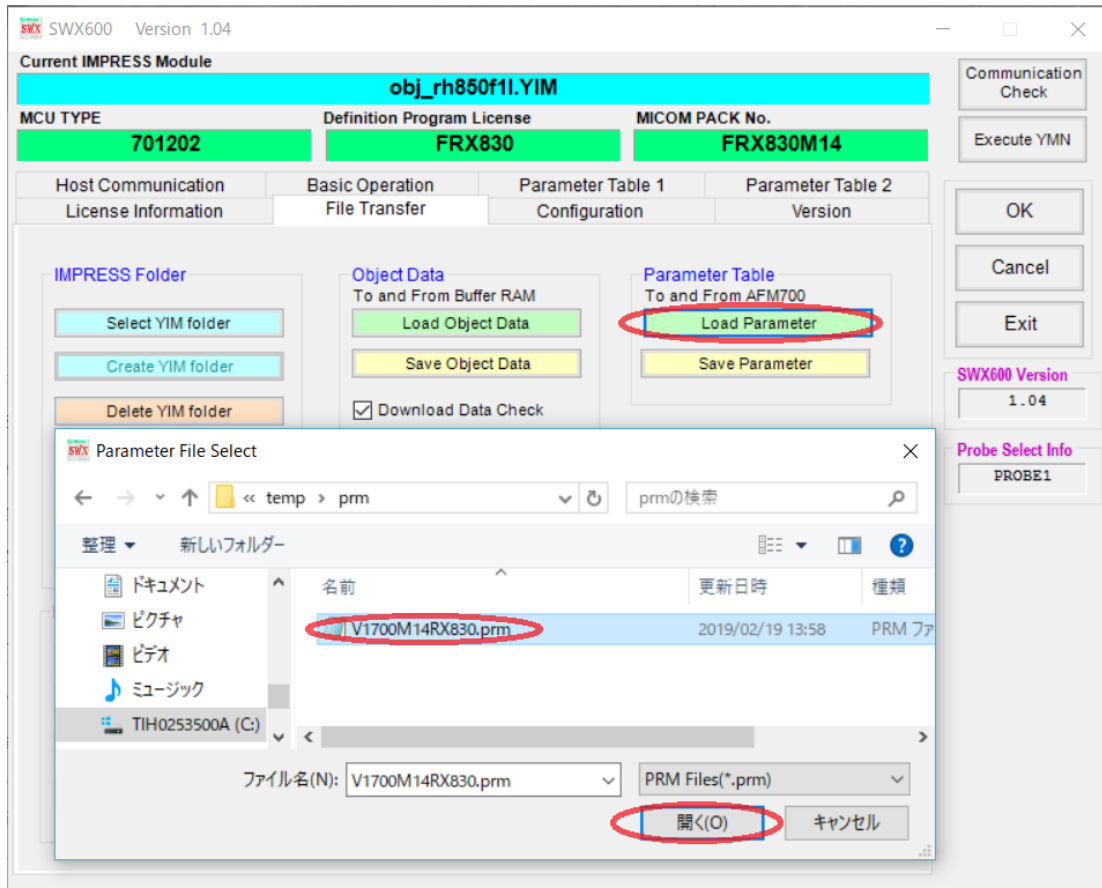

4.4.3. Downloading bundle files

Downloading necessary bundle files by clicking “Copy File (Load)” button in “Bundle File” group of “File Transfer” tab. KEY file, AMK file, and BTP files are the major bundle files.

Bundle file	<ul style="list-style-type: none"> ● Collective term of the files for setting the programming environment. Definition program file, parameter file, and programming object are not included in the bundle file. ● The files that users created by software provided by us are included. e.g. KEY file
KEY file	<ul style="list-style-type: none"> ● Extension is .KEY. ● This is a file for security check of the device. ● The file is created by using AZ481 (KEY file generator). <p>➔ For more details about KEY file, refer to “8. KEY file” of this manual.</p>
AMK file	<ul style="list-style-type: none"> ● Extension is .AMK. ● This is included in micom pack. ● Master KEY file for security check of the device.
BTP file	<ul style="list-style-type: none"> ● Extension is .BTP. ● This is included in the Micom pack. ● This file is writing control program.

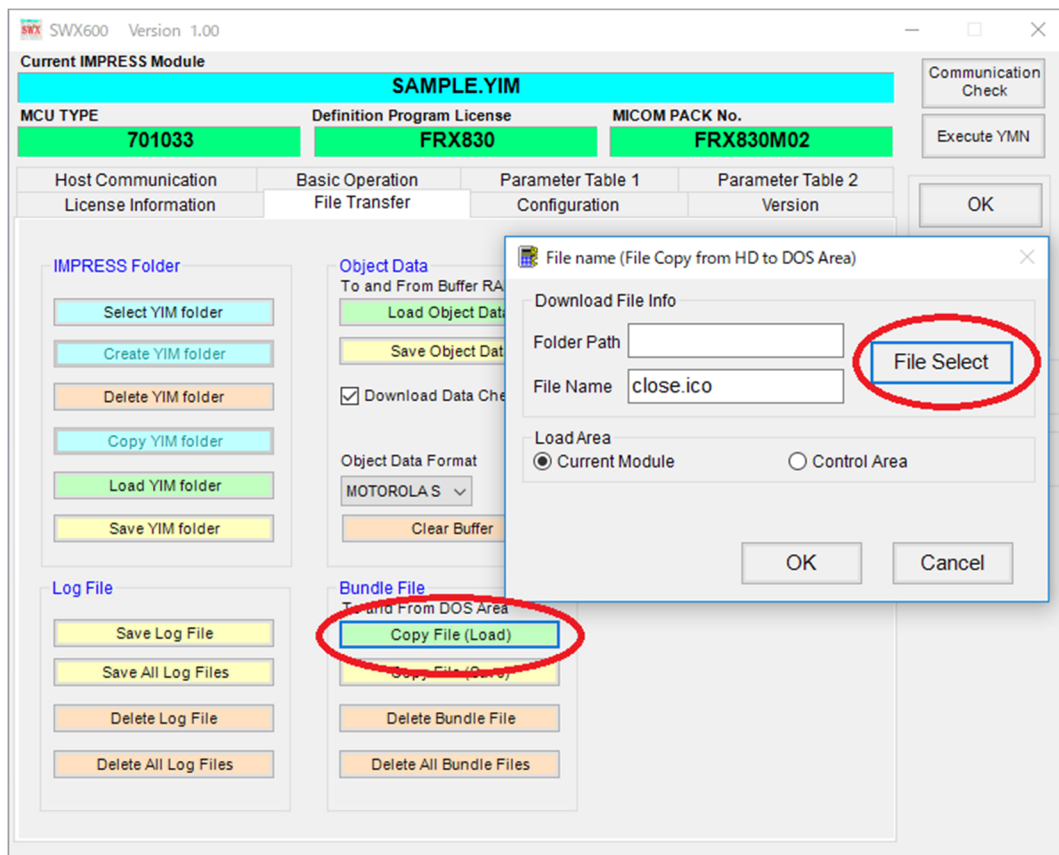

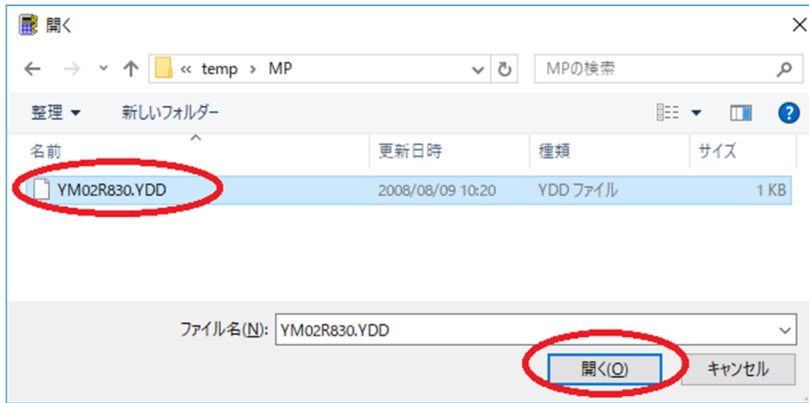

4.4.4. Setting Parameters

In “4.4.2 Downloading a parameter file”, downloaded parameter file is the initial settings configured by us. Changing the setting may be necessary based on target system.

Set parameter on “Parameter table 1” tab.

Mainly, MCU clock frequency, detection level of the target power (TVcc threshold), communication bound rate, and so on are set on this tab.

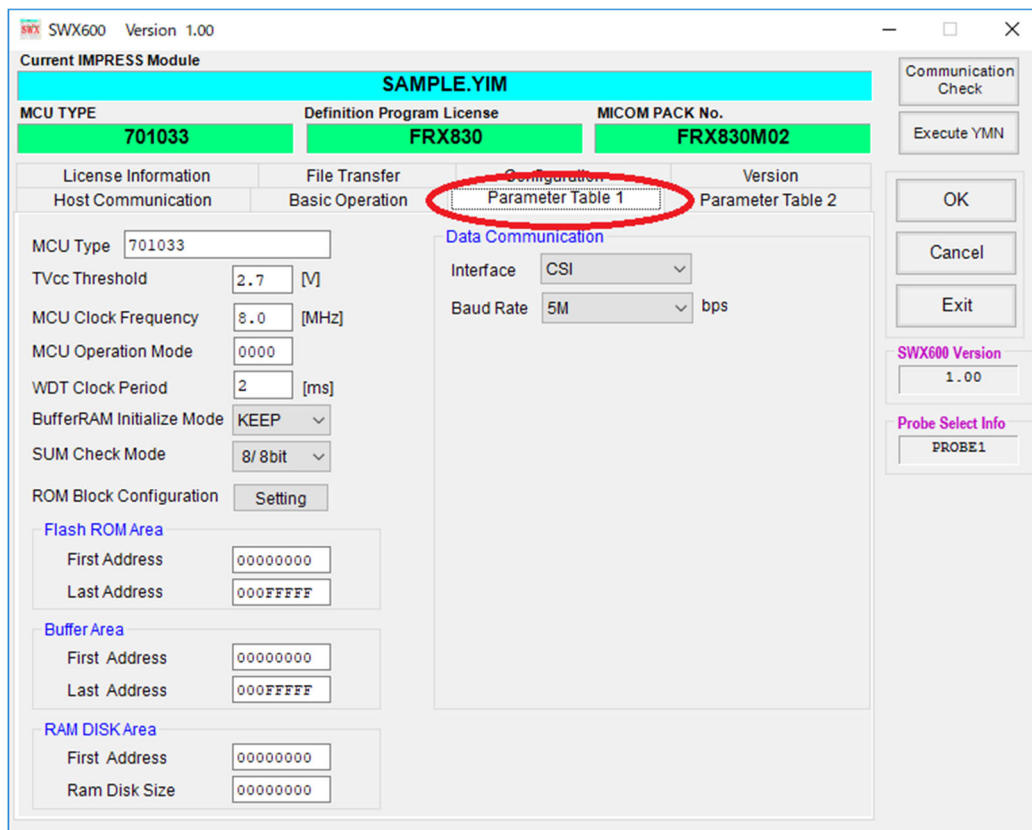

For more details about parameter table, refer to definition program manual and micom pack manual.

4.4.5. Downloading object file to be programmed

Click “Clear Buffer” button in “Object Data” group on “File Transfer.”

Click OK button on confirmation window.

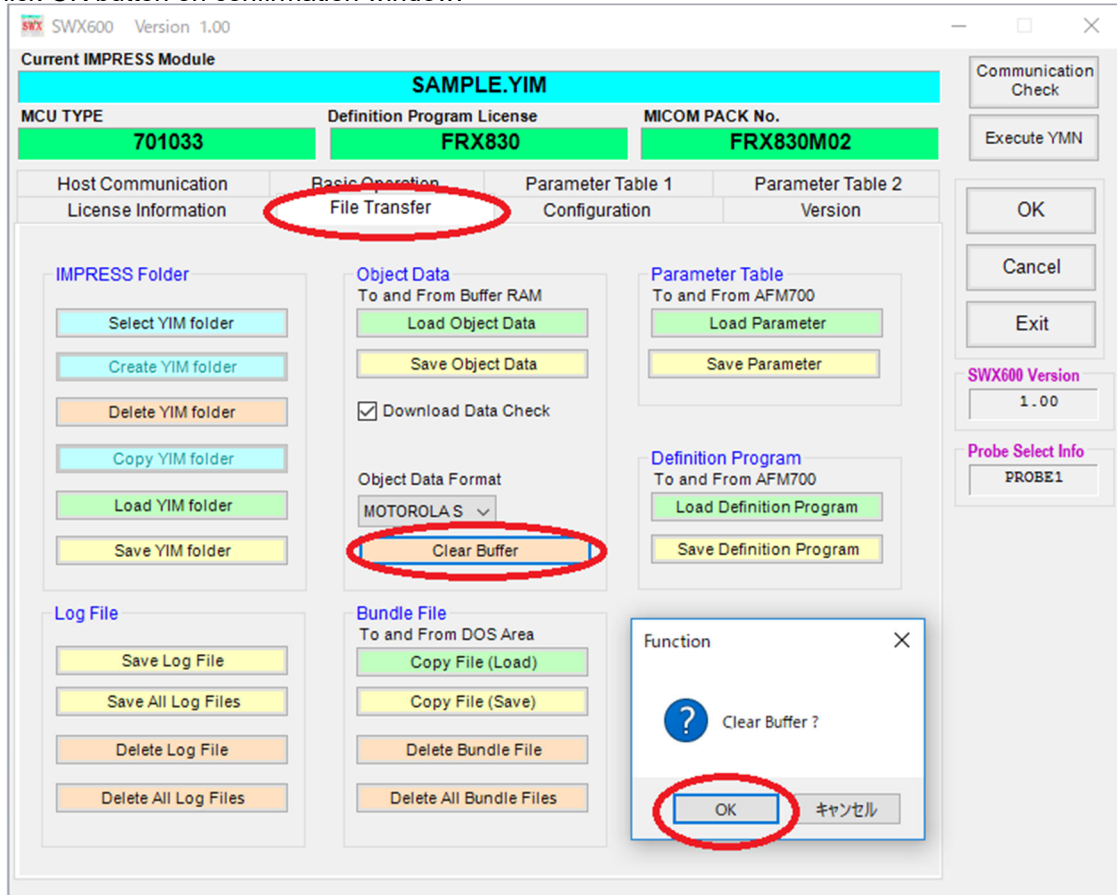

Object file to be programmed is downloaded by clicking “Load Object Data” button in “Object Data” on “Load Object Data.” Object Data is loaded to buffer memory of SD card by executing downloading object file.

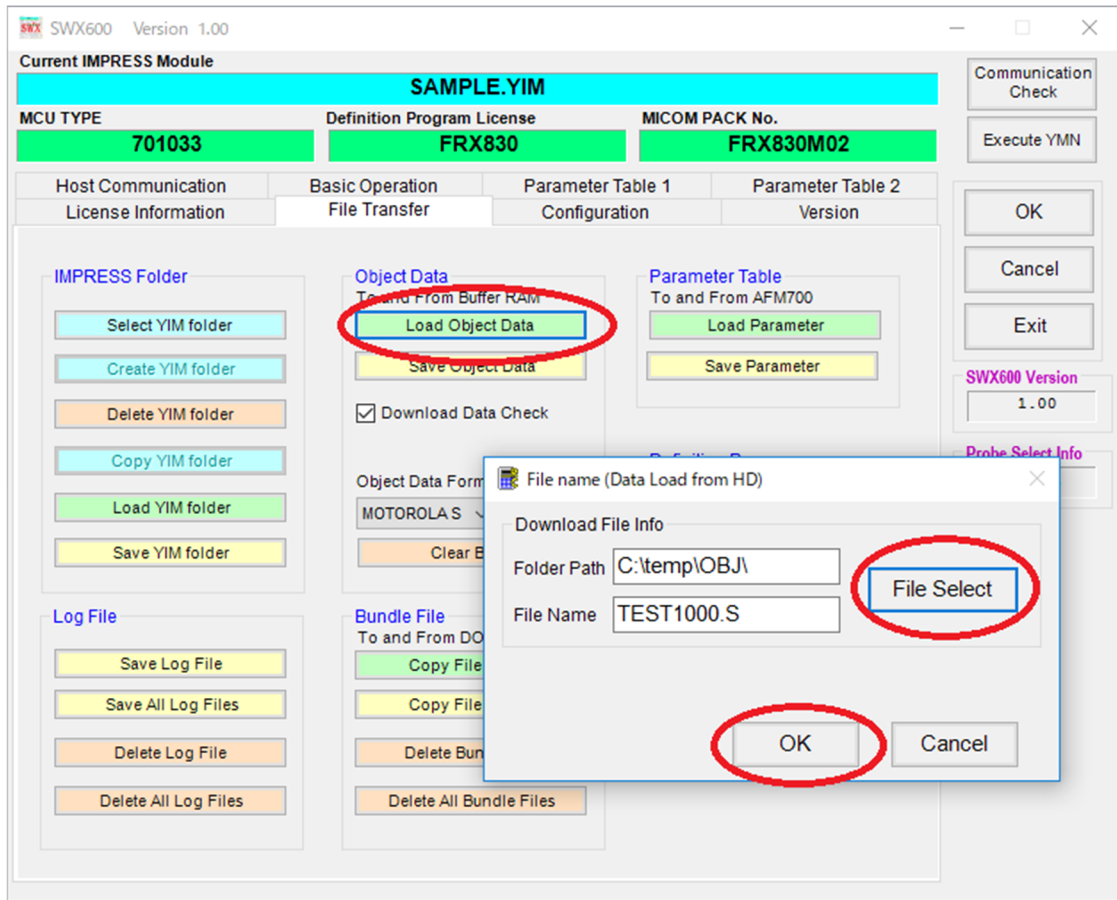

Setting of programming environment is completed.

Buffer memory	<ul style="list-style-type: none"> ● Data to be programmed to device is saved in buffer memory. ● Downloaded object file is converted to binary data, and the data is saved in buffer memory. ● The data is no deleted after the programmer is powered off because buffer memory is on SD card.
---------------	--

4.5. Connecting to Target System

This chapter explains the typical connection example between target system and NETIMPRESS avant.



Connection may vary depending on programming environment.

Check definition program and Micom pack manuals for more details.

Manuals of main unit, probe cable, definition program and micom pack are available on our web site.



https://support.dts-insight.co.jp/en/product/support_netimpress/download/

https://support.dts-insight.co.jp/en/product/support_netimpress/micom/

<https://support.dts-insight.co.jp/en/mypage/usages/>

- **Types of probe**

Connect the programmer main unit to target board by using a suitable probe suitable for your programming environment.

<p>PHX400</p>	<p>Standard probe</p> <p>Target connector: Dsub 25pin</p> <p>Standard interface: serial, SPI, JTAG, SWD, BDM</p> <p>Various interfaces can be supported by adding probe logic license.</p> <p>Addable probe logic license: PLX420, PLX430, PLX440, PLX460</p> 
<p>PHX410</p>	<p>CAN/CAN-FD probe</p> <p>Target connector: Dsub 9pin</p> <p>Standard interface: CAN, CAN-FD</p> <p>Addable probe logic license: -</p> 

● Wire Connection

Connect probe and target system referring to “Connecting to a Target system and Connector.”

e.g. Micom pack RX830M00 supporting RH850/F1L of Renesas

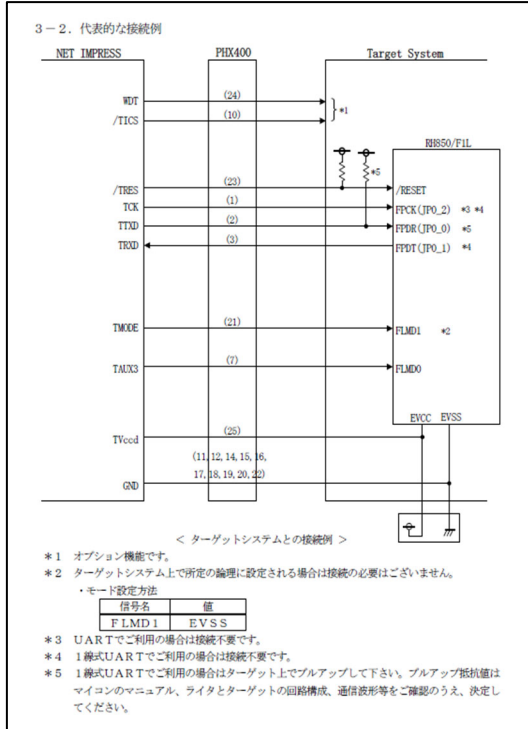

3. ターゲットシステムとの接続と専用コネクタ

3-1. 信号一覧表
本マイコンパックをご利用頂いた場合のターゲットプローブコネクタ端子の信号表を示します。

マイコン信号名	NET IMPRESSの標準信号名	マイコン信号名
EVSS	GND (15) (1)	GND EVSS
	TVpp1 16 (2)	TVcc EVCC
	TVpp2 17 3	Vcc
ターゲットプローブ用信号	WDT (18) (4)	TRES 正論理/TRES
	TAUX3 TVpp1c 19 (5)	/TRES /RESET
	FLMD0 TAUX4 TVpp2c (20) (6)	TCK (JP0_2)
	reserved 21 7	reserved
	reserved 22 8	reserved
	TAUX 23 9	TAUX2 (TRW)
	TBUSY 24 (10)	/TICS ターゲット用信号
	TIO 25 11	TAUX5 (/TOE)
	TVccs 26 (12)	TMODE FLMD1
FPDT (JP0_1)	TRXD (27) (13)	TTXD FPDR (JP0_0)
EVSS	GND (28) (14)	GND EVSS

ターゲットプローブ信号表 (FRX830M00)

- は、必ず接続頂く信号線です。
- () は、必要な時のみ接続してください。
- も () も印のない信号線はターゲットシステムの回路には接続しないでください。詳細については、弊社サポートセンターにお問い合わせください。
- 各信号線のインタフェース回路については、プログラマ本体の『Instruction Manual』をご覧ください。

● Connection of the programmer and target system

Checking the type of the target probe and the wire connection, connect the main unit and target system



Caution about powering on/off flow.

- Powering on: The programmer is powered on, and then the target system is powered on.
- Powering off: The target system is powered off, and then the programmer is powered on.

5. Programming

5.1. Programming Procedure

1. Connect the programmer and target system.
Making sure the connection is correct, power the programmer on.
2. Startup SWX600 (remote controller) after connecting host PC and the programmer.
If the setting of SWX600 is completed, "Communication Check" is automatically executed, and the host PC and the programmer is connected.
 - ➔ Check Ethernet setting again according to "3.2 Setting up Ethernet Connection" if Ethernet connection is not established.
3. Select YIM Folder.
Select YIM folder that the programming environment is set, and then click "Select YIM folder" button in "IMPRESS Folder" on "File Transfer" Tab and "Select" button.

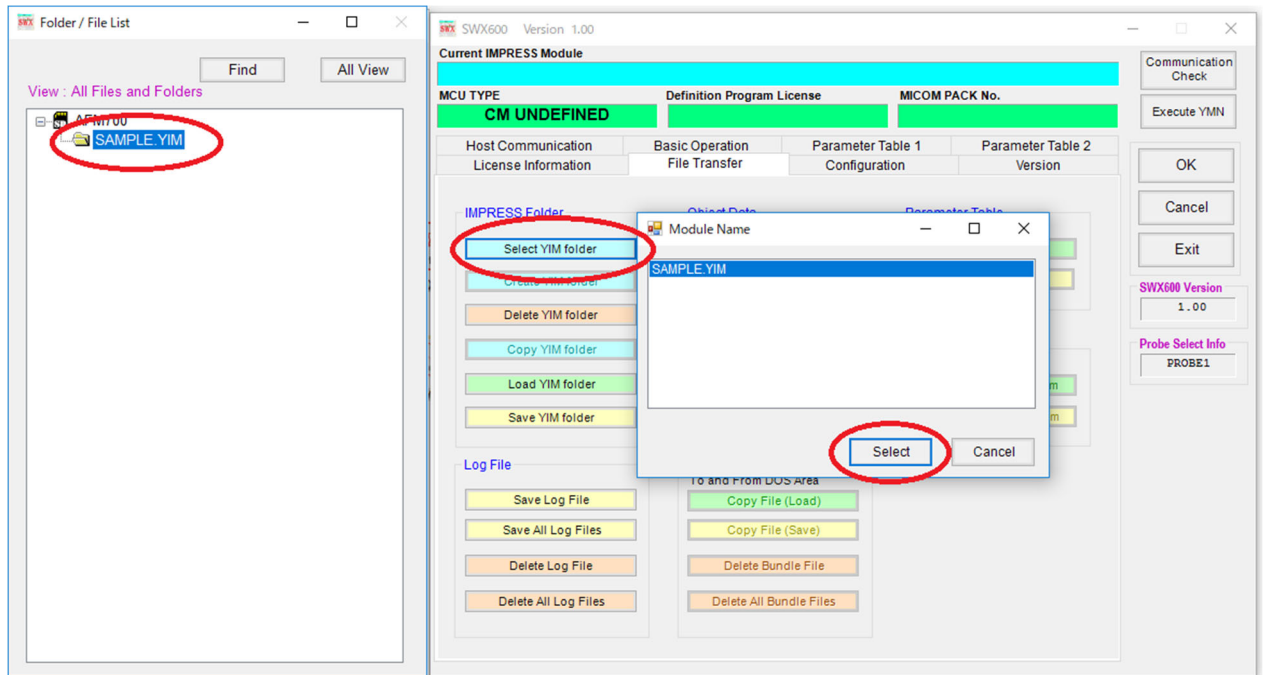

4. Power on target system.



Caution about powering on/off flow.

- Powering on: The programmer is powered on, and then the target system is powered on.
- Powering off: The target system is powered off, and then the programmer is powered on.

5. Execute Programming

Programming is executed by each device function button in “Device Function” group on “Basic Operation” tab. E.P.R is normally executed. E.P.R stands for Erase, Program and Read Verify.



Device function can have different meaning depending on definition program.
For more details about device function, refer to definition program manual.

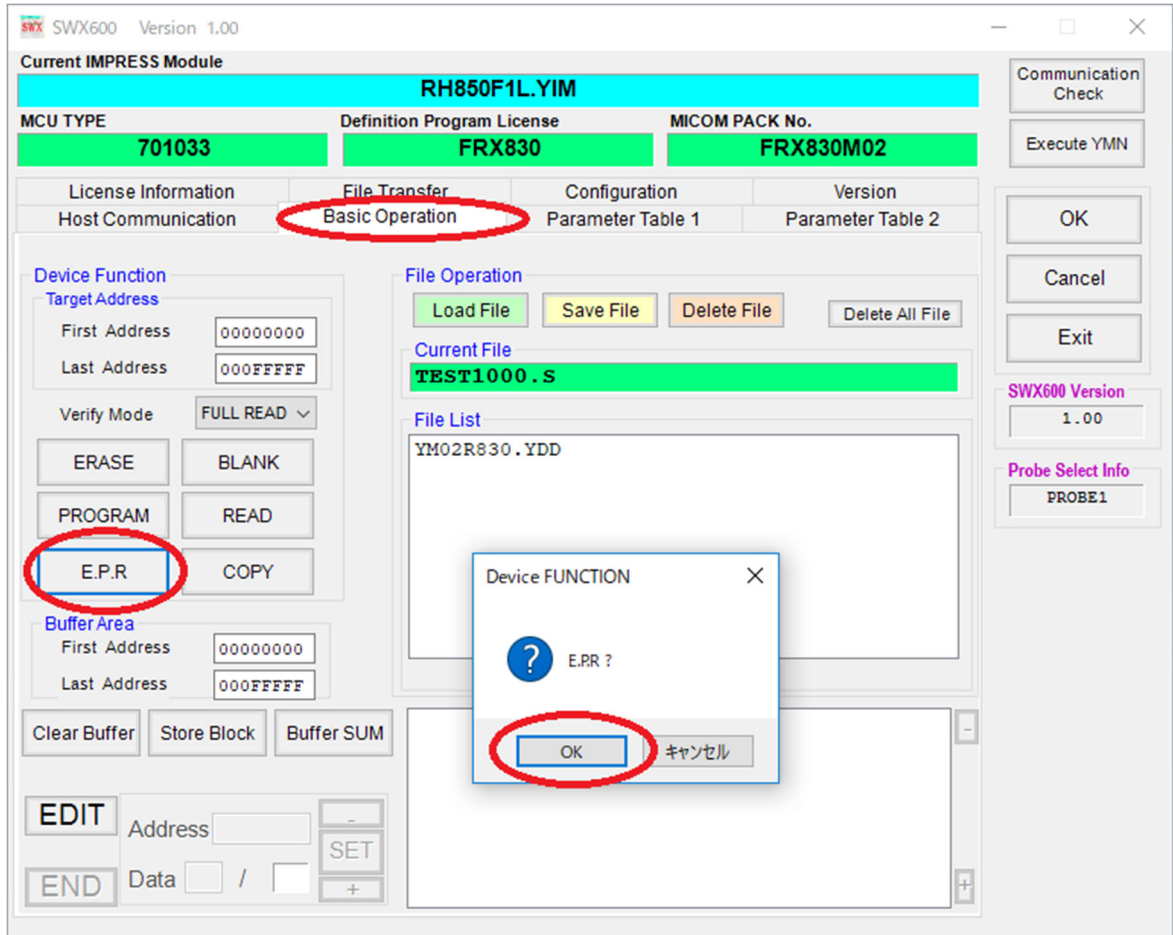

6. End SWX600 (remote controller) by clicking close box of SXW600 after programming is completed.

7. Power off target system and the programmer.



Caution about powering on/off flow.

- Powering on: The programmer is powered on, and then the target system is powered on.
- Powering off: The target system is powered off, and then the programmer is powered on.

6. Screen of SWX600(Remote Controller)

Downloading files, setting programming environment, and executing device function by using SWX600(remote controller).

SWX600 is configured by 8 tabs.

- Host interface Configuration: setting connection between SWX600 and the programmer
- Basic Operation: executing device functions
- Parameter Table 1: setting parameter
- Parameter Table 2: setting parameter (Password is required.)
- License Information: setting license
- File Transfer: downloading files
- Configuration: Setting NETIMPRESS main unit itself and updating NETIMPRESS main unit system
- Version: each version information

This chapter explains the following screens used frequently.

Basic Operation, Parameter Table 1, File Transfer

➡ For other functions and details of the operation, see 「SWX600 NETIMPRESS avant Software manual」 (SWX600mnEnn.pdf).

6.1. Basic Operation (Device Function screen)

You can execute device functions on Basic Operation Screen.

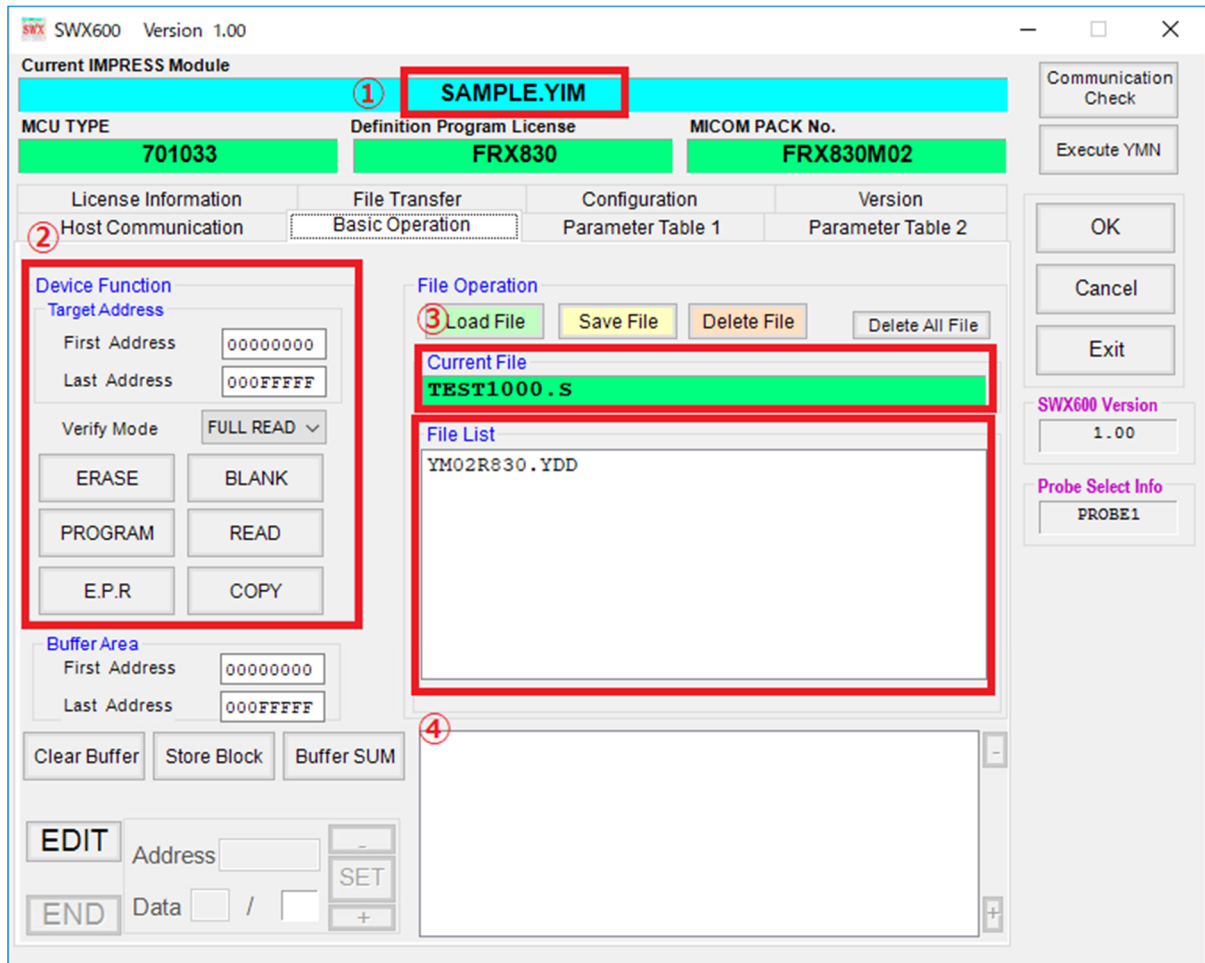

(1) Current IMPRESS Module

YIM folder name currently selected is shown here. (In this example, SAMPLE.YIM is selected.)

(2) Device Function

The device functions are executed.

(3) Current File

The name of object file which is loaded in buffer memory currently. Displays the file name of the object specified by Load Object Data on the Object Data To and From Buffer RAM screen on the 「File Transfer」 tab.

Displays the file name of the object specified by Load Object Data

(4) File list

It shows bundle files in YIM folder currently selected. You can find indicated file by Copy File(Load), "Bundle File to and From DOS Area" in File Transfer tab.

6.2. Parameter Table 1 (Parameter Setting Screen)

You can set programming according to your environment on Parameter Table 1 screen.

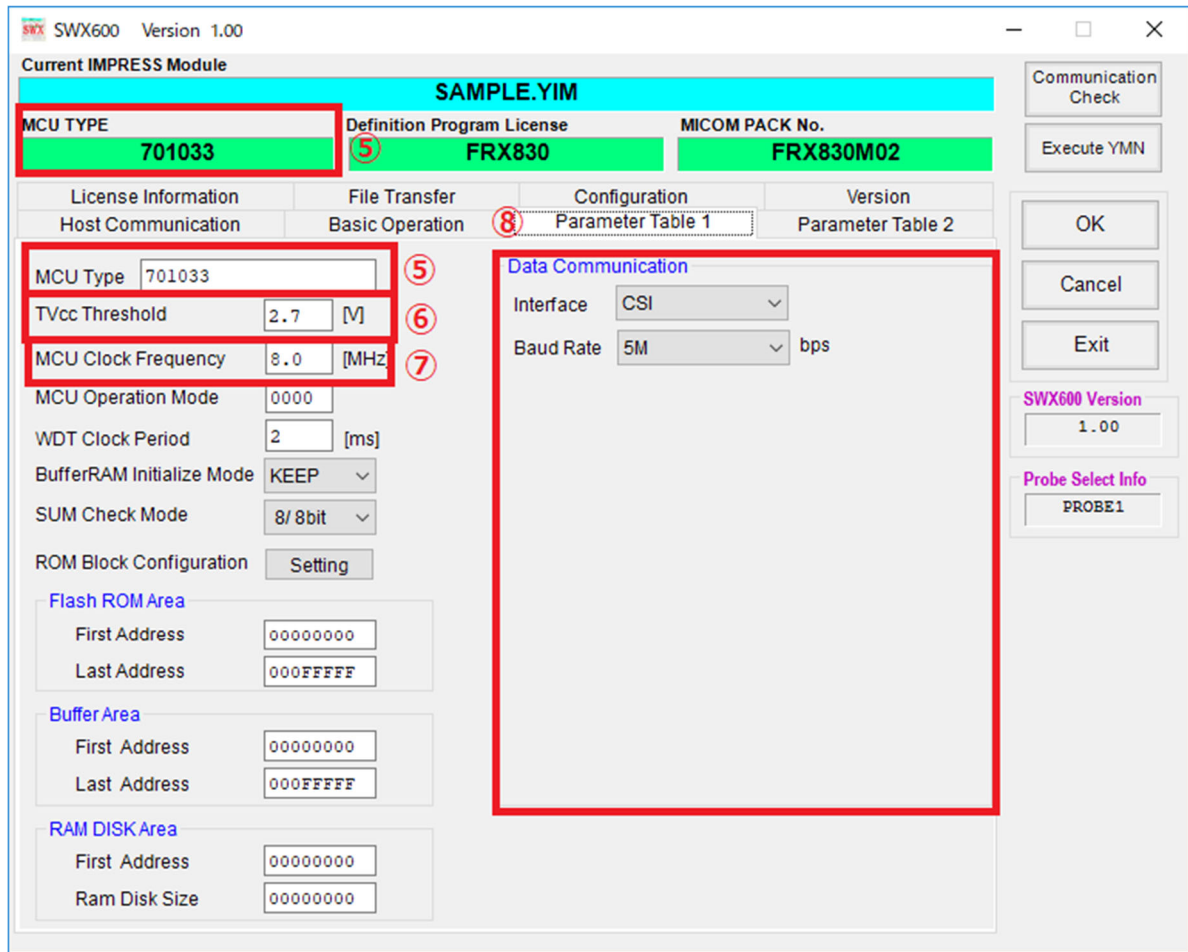

(5) MCU TYPE

By default it shows device name etc. The name set up at this MCU TYPE is shown at LCD top of programmer main unit.(reference shows 701033.)

(6) TVcc Threshold

When executing device function, NETIMPRESS avant uses this value as the threshold to check if the target power is turn on or not. Normally, set the value to about 90% of the target power voltage

(7) MCU Clock Frequency

Set operating Clock frequency of target here. (0~99.9[MHz])

➡ Please see your definition program manual for parameter detail.

(8) Data Communication

Configure the communication setting between a device and the programmer. Set the communication method and baud rate.

6.3. File Transfer (File Transfer Screen)

You can execute in File Transfer tab as follows: adding license, transfer of necessary file for programming environment setting, and creating, selecting, copy, deleting of YIM folder.

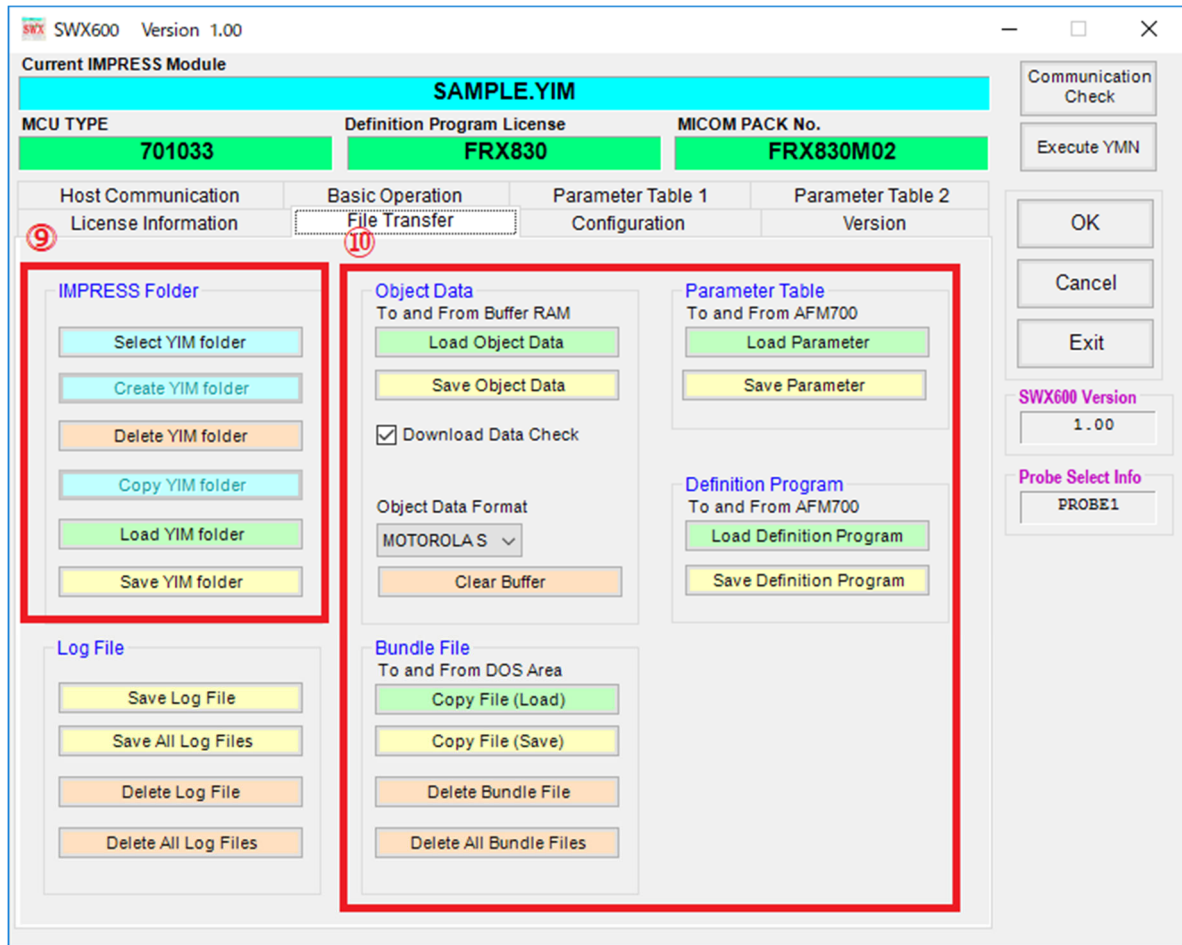

(9) IMPRESS Folder

The buttons are used for operating YIM folder selected in Folder/File List Window.

Folder/File List is displayed in new window.

(10) File Transfer

Object Data:

It is used to transfer to buffer memory of object to program, and to save data in buffer memory to host PC.

Bundle File:

It is used to transfer bundle file to programmer and save in host PC.

Parameter Table:

it is used to transfer parameter file to programmer and save in host PC.

Control Module:

It is used to transfer definition program file to programmer and save in host PC.

7. YIM Folder

7.1. YIM Folder Structure

YM Folder controls Programming object of SD card and programming environment.

- (1) You can create YIM Folder in SD card plurally and switch YIM folder as current by functional operation
- (2) You can configure BTP File(*.BTP),User OBJ(*.KEY、 *.YSM etc,) in YIM folder.
- (3) You can configure each Buffer file (BUF.SYS), Definition program file(CM.SYS) every created YIM folder.

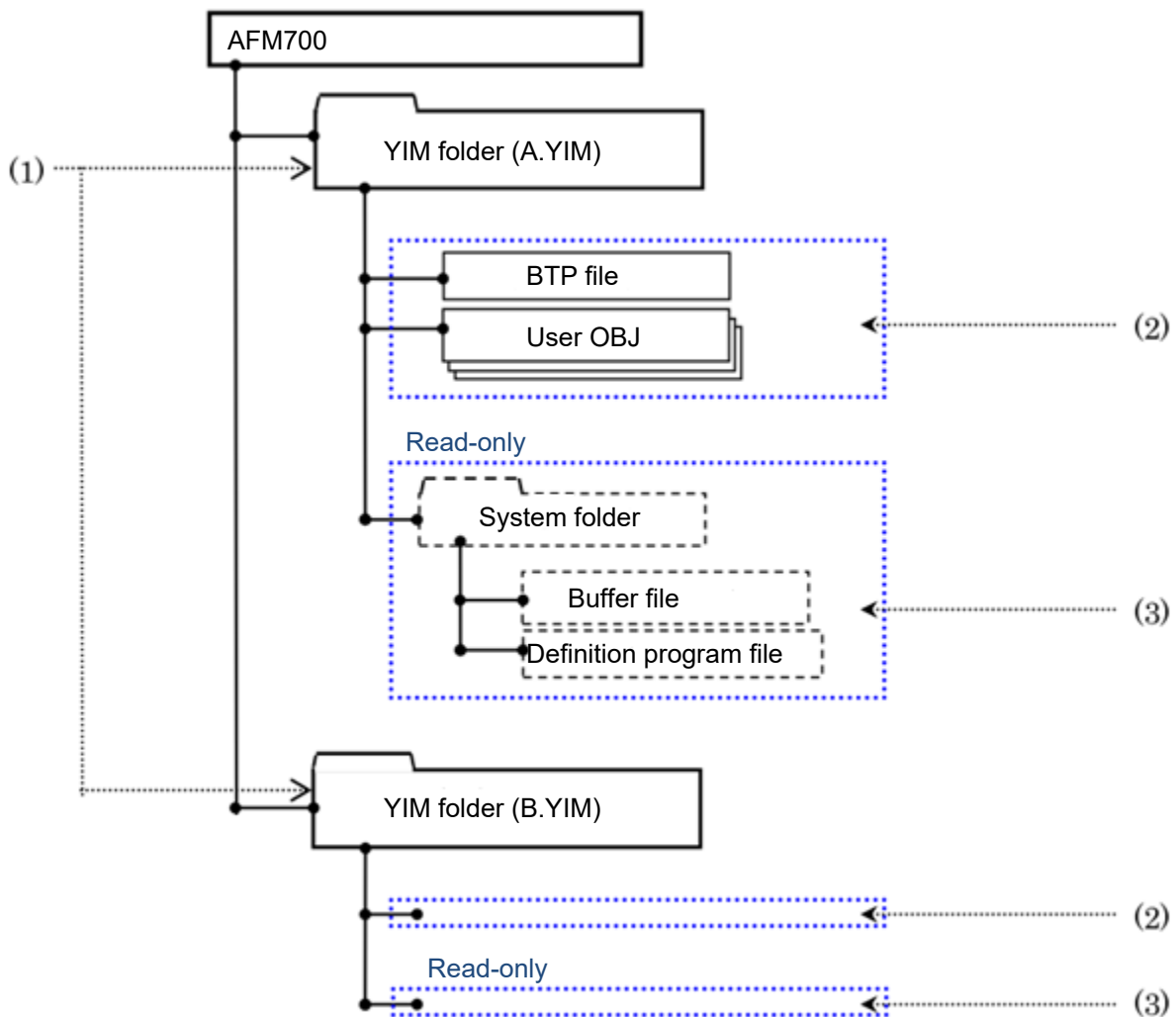

Please do not change and erase BUF.SYS & CM.SYS file. In case any change and erase, it has possibilities to occur unsuccessfully programming



You can check the file composition by SWX600 (remote controller), but can not refer read-only area.



Please refer "4.3 YIM folder " in this manual for detail to create YIM folder .

7.2. Managing the programming environment

Created YIM folder in the SD card can be stored in the host PC by using SWX600(remote controller). You can re-create the same programming environment by transferring the saved YIM folder to another working environment.

This chapter explains how to save the YIM folder, and how to load it.



Same definition programming license is required in the destination SD card if you want to share the same programming environment with more than one SD card by transferring YIM folder.

7.2.1. How to save YIM folder (Operation for the original folder)

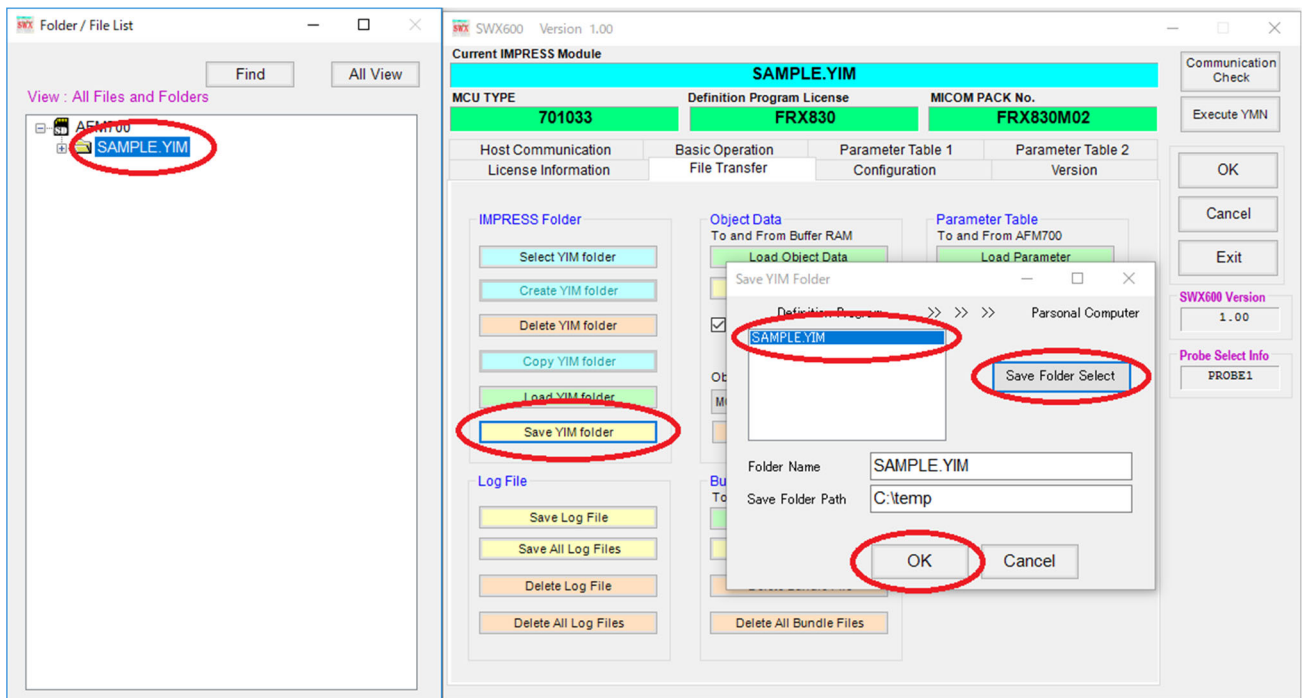

7.2.2. How to load YIM folder (Operation for the destination SD card)

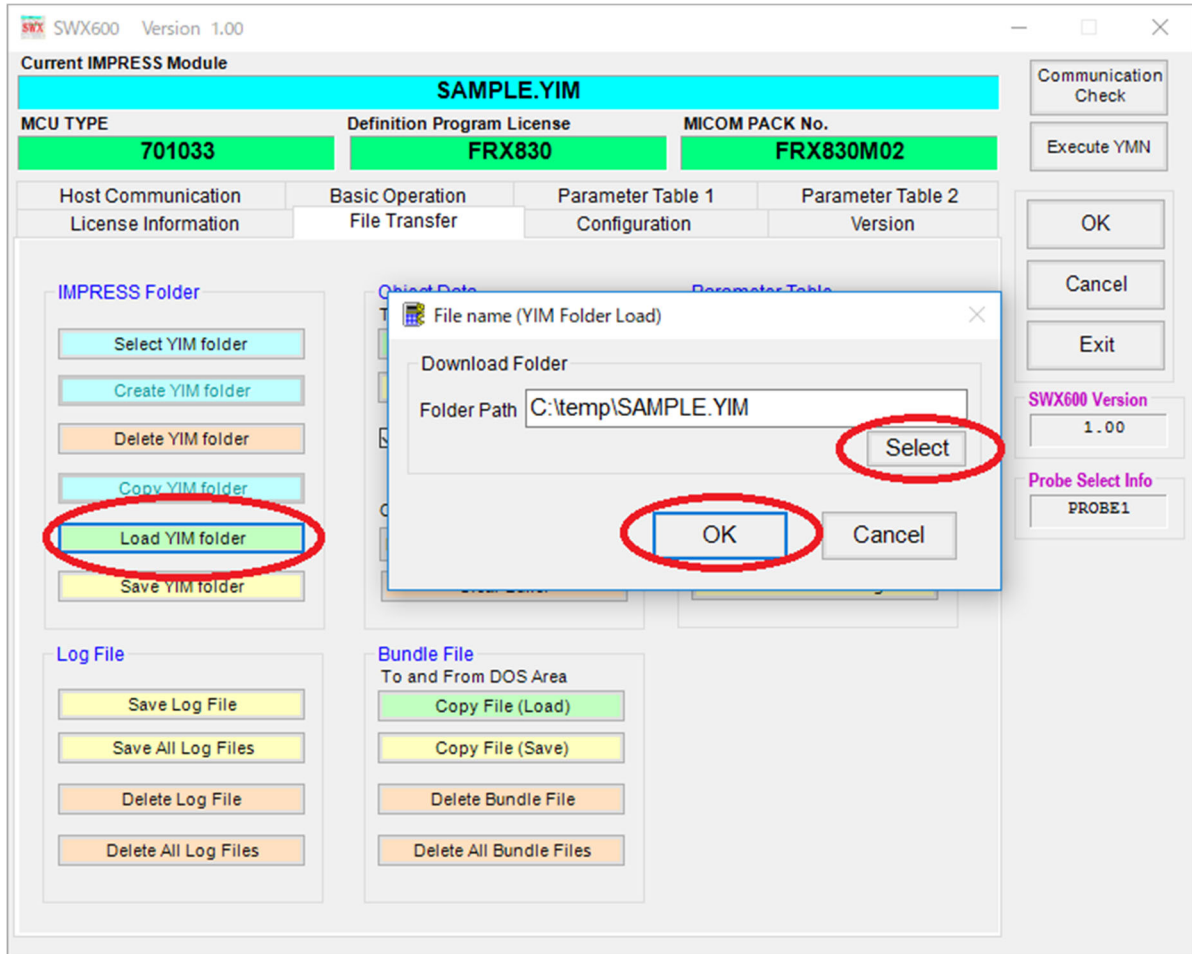

8. KEY file

Some MCU has a security feature.

With the basic security feature, an encrypted data (ID code), embedded in the MCU, is sent from the programmer when the programmer accessing (read/write) the MCU, and the access will be failed if the data is not matched. Therefore the flash memory can be accessed only when the programming contents are obvious. By this way, it can prevent the wrong data programming and reading.

NETIMPRESS avant creates KEY file with an encrypted data (ID code) for passing the security at programming.

KEY file	<ul style="list-style-type: none">● This is a file for checking the security by issuing the ID code to device automatically when the programmer executed the target function.● Security ID address, ID size and ID data value are stored.● KEY file has to be in the YIM folder. Download this file by using AZ990 (air Connect) as a bundle-file.
----------	--

➔ For details on how to download the bundle-file, see Chapter 4.4.

! Specification of security varies depending on the MCU. For details, see the manuals of definition program and Micom pack.

8.1. Creating KEY file

Create the KEY file by using AZ481 (KEY file generator).

(1) Start up AZ481 (KEY file generator).

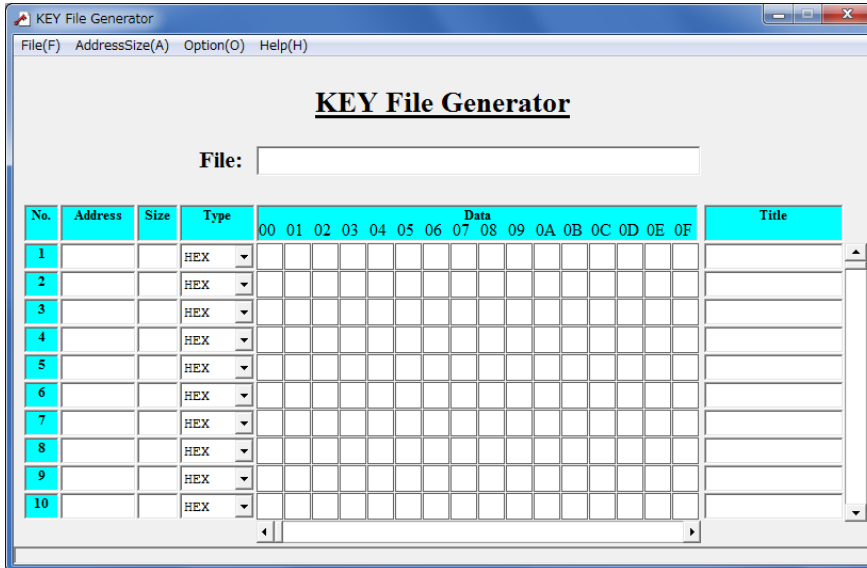

(2) Input the security ID address, ID size and ID data value.

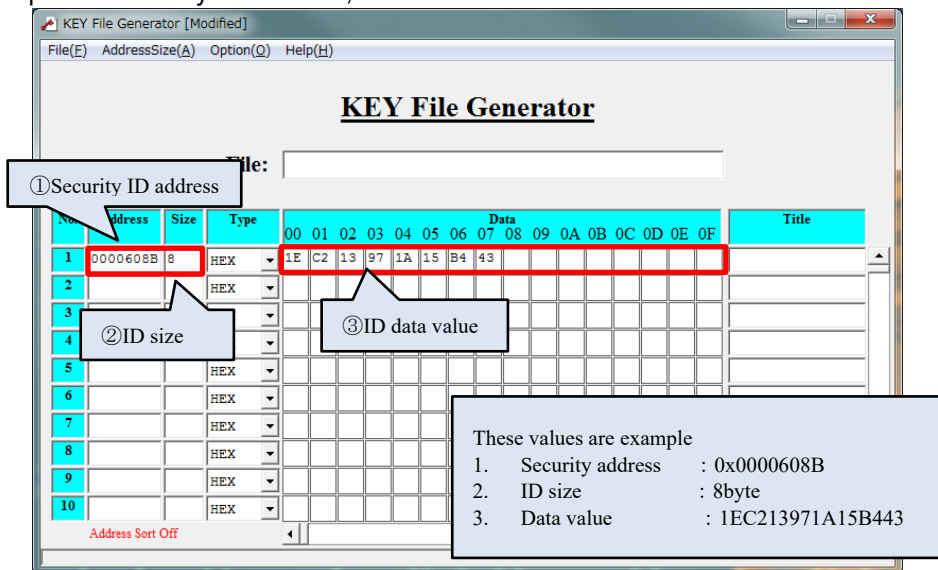

(3) Save KEY file. (From the menu bar [File] menu, select <File Save>.)

Select the KEY file (*.KEY) as a file type, and then specify a path for saving the KEY file.

Set the file name of KEY file, and then click the **Save** button.

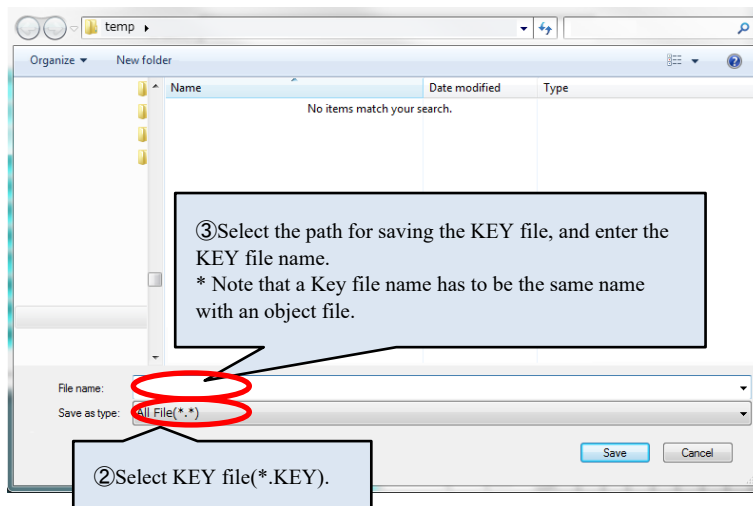
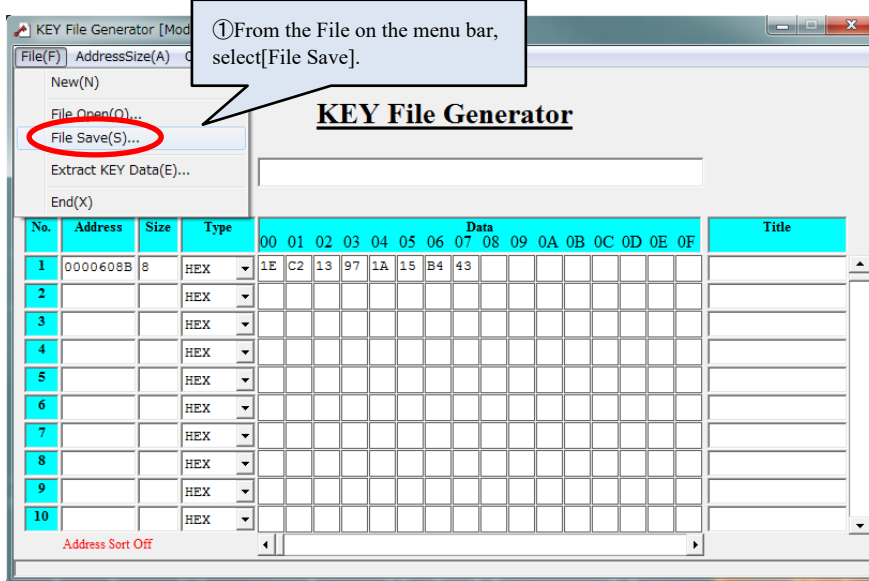

Note that YSM file name has to be the same name with a user object file.

9. Check the SUM value in the buffer of YSM file

By saving the SUM value of buffer memory in YSM file, you can check the SUM value of the user object whenever you execute the device function. By using this function, you can prevent the programming of incorrect object data when the buffer memory of programming object was corrupted accidentally.

9.1. YSM file

Create the YSM file you saved the SUM value of buffer memory, and then place it in YIM folder.

After the device function is completed, the programmer automatically compares the SUM value in the YSM folder with the SUM value at when the device function was executed. If the values are not matched, it will result in an error (YSM CHECK ERROR).

Download the YSM file by using SWX600(Remote controller) as a bundle-file.

➔ For details on how to download the bundle-file, see Chapter 4.4.

9.2. Creating YSM file

This chapter explains how to create the YSM file.

(1) Start up AZ481 (KEY file generator).

(2) Create the YSM file by following the steps below.

Select [Address Sort Off] from Option on the menu bar.

Enter the data.(Normally, enter the lines of No.1 and No.2)

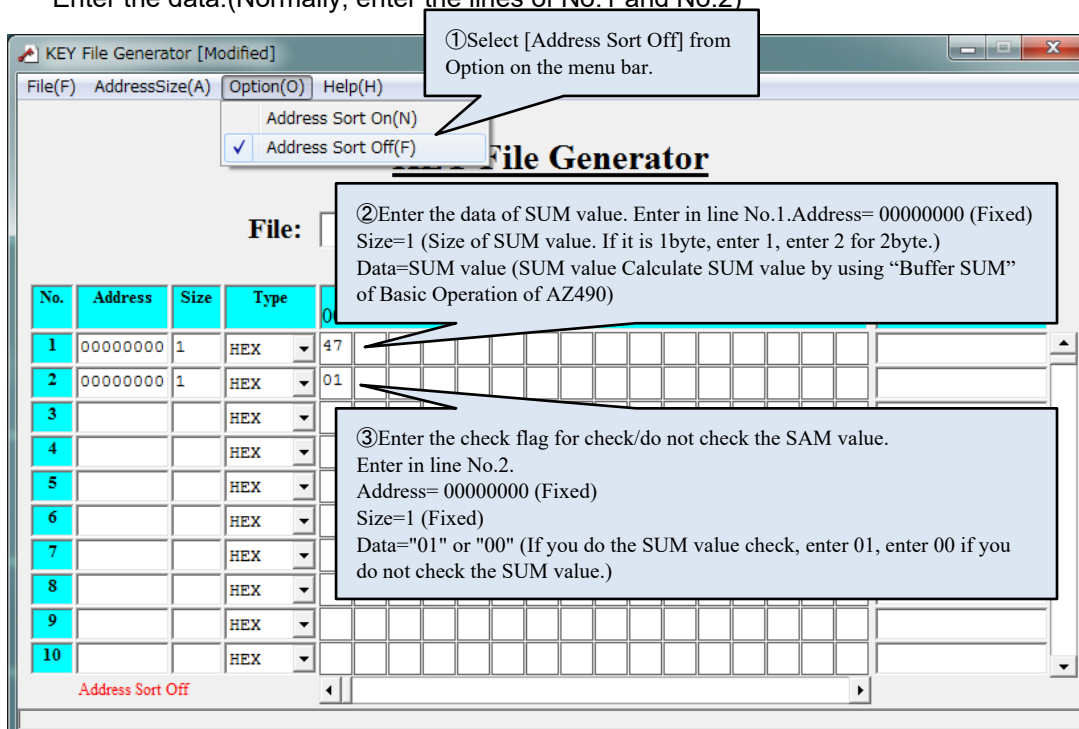

- (3) Save YSM file. (From the menu bar [File] menu, select <File Save>.)
 Select the YSM file (*.YSM) as a file type, and then specify a path for saving the YSM file.
 Set the file name of YSM file, and then click the **Save** button.

! Note that YSM file name has to be the same name with a user object file.

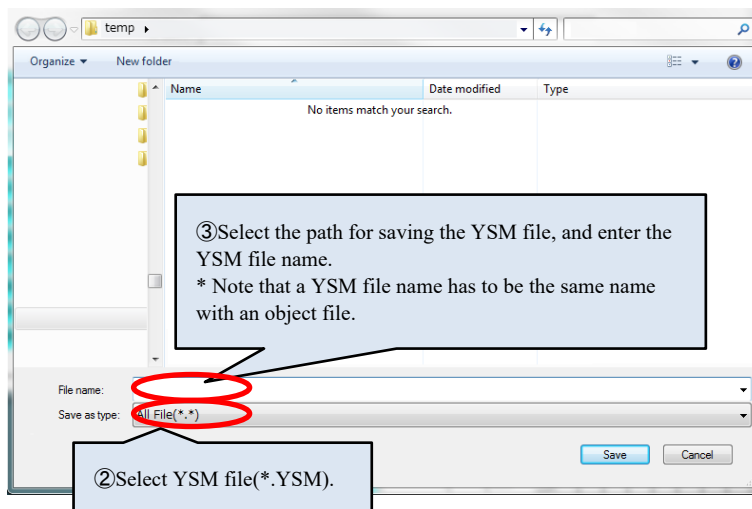
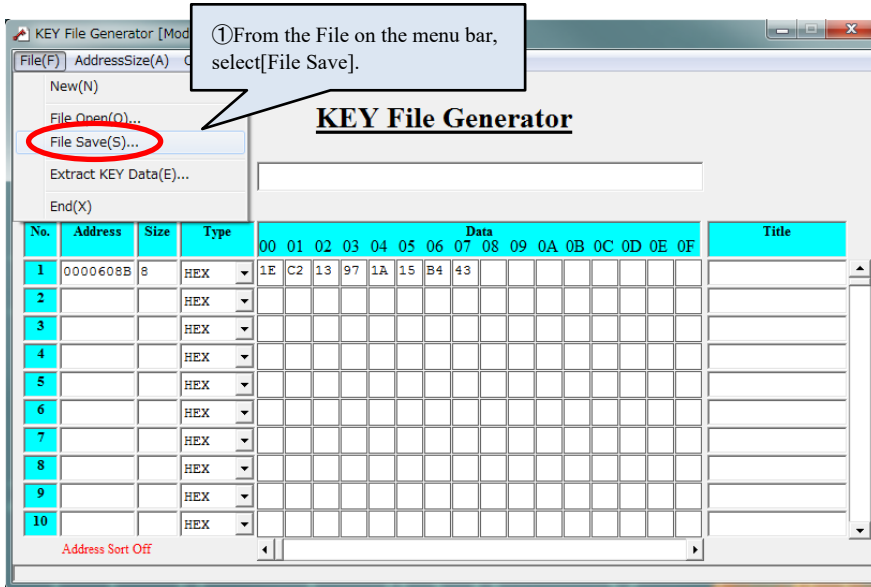

✓ The SUM value check function which uses YSM file can also check the data in a certain area of buffer memory. You can also check the versions of the user object file by using this function.

10. EXT Keys & CSB File

NETIMPRESS avant has two EXT keys: EXT1 and EXT2.

You can execute multiple commands sequentially by pre-assigning a command sequence to the keys. (Up to 16 sequential executable commands can be assigned.)

A CSB file is required to assign command sequences.

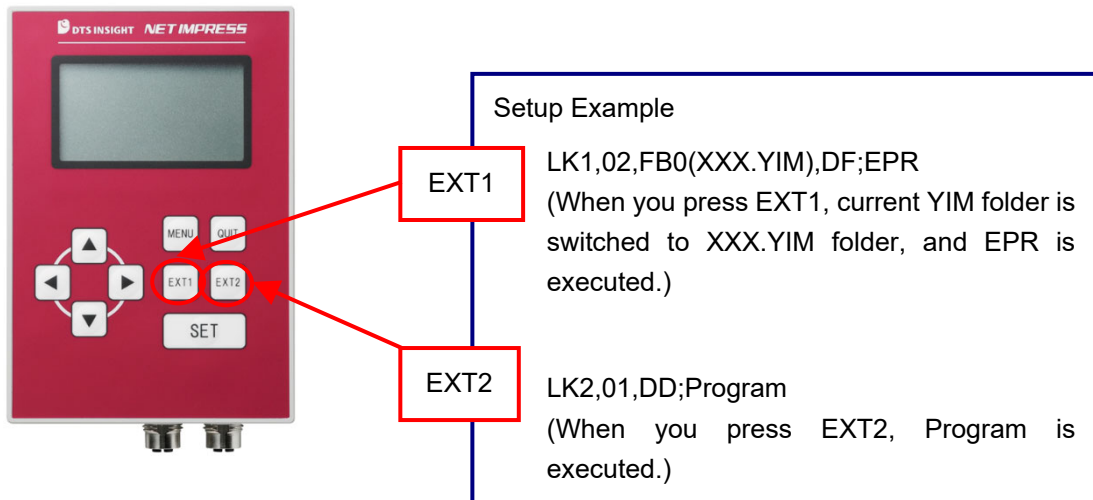

The name of the CSB file is arbitrary, but please save it with an extension (.CSB).

Only one CSB file can be placed in the root directory of the SD card.

10.1.1. CSB File format

The format of CSB is as follows. Place the ‘,’ between commands. Use a single-byte character for “,”.

LK1,count,cmd1,cmd2,...,cmd16;comment
LK2,count,cmd1,cmd2,...,cmd16;comment
 (1) (2) (3) (4) (5)

(1) KEY No. code (3 bytes)

LK1 = Assignment to EXT1 key.

LK2 = Assignment to EXT2 key.

(2) count (2 bytes)

Enter how many commands are executed in a command sequence. Decimal notation is used. Therefore after “09” will be “10”, and the Maximum is 16.

For unused keys, set “00”.

(3) cmd1, cmd2, ..., cmd16:

Enter a command code of the command what you want to execute. Refer the list below.

Command definition list.

Command code	Description
F0(XXXXXXXX YYYYYYYY)	Device function area setting (XXXXXXXX: First address, YYYYYYYY: Last address) *These settings can be omitted. When omitted them, the area will be the entire flash ROM area.
F1(XXXXXXXX YYYYYYYY ZZ)	Block store (With this command, you can program any same data into specified range in buffer memory.) (XXXXXXXX: First address, YYYYYYYY: Last address, ZZ: data) These settings can be omitted. When omitted, the area will be the entire flash ROM area and data will be 00.
F2	Buffer memory clear
FF1(XXXXXXXX.YYY)	Load file (XXXXXXXX.YYY: name of loading file)
FF5(XXXXXXXX YYYYYYYY)	Transfer address setting (XXXXXXXX: First address, YYYYYYYY: Last address) These settings can be omitted. When omitted, the address becomes the entire flash ROM area.
D9	Blank (Device function)
DC	Erase (Device function)
DD	Program (Device function)
DE	Read (Device function)
DF	E.P.R. (Device function)
FB0(XXXXXXXX.YIM)	Switching current YIM folders (XXXXXXXX.YIM: YIM folder name)
FBD(XXXXXXXX.YMN)	Execution of current YMN file (XXXXXXXX.YMN: name of YMN file to be executed.)



Maximum number of commands in CSB fail is 16 commands.

(4) Command delimiter “,” (1 byte)

Shows the command delimiter between (3) and (5).

(5) Comment (Any characters + CRLF)

Describe a comment when you want to give a comment to the command. When you do not need a comment, you can finish at (4).



Make sure to write Newline (CRLF) code at the end of the line when you describe a comment.

10.1.2. Example of Creating CBS File

Example 1. (Standard attached sample Test.csb)

A Test.csb file is attached to each definition program. The description contents of this CSB file are shown below.

[Description]

LK1,01,DF;EPR

LK2,01,DD;Program

[Execution Sequence]

EXT1 key = Executing E.P.R., EXT2 key = Executing Program

*Precondition: YIM folder should be selected.

Example 2 :

[Description]

LK1,01,FB0(SAMPLE.yim);CHANGE YIM

LK2,01,DF;E.P.R

[Execution Sequence]

EXT1 key = Loading specified YIM folder, EXT2 key = Executing E.P.R.

When you press "EXT1" key, "SAMPLE.YIM" is downloaded as Current IMPRESS Module.

When you press "EXT2" key, EPR is performed to the target with the contents of "SAMPLE.YIM".

Example 3 :

[Description]

LK1,04,FB0(SAMPLE_1.yim),DF,FB0(SAMPLE_2.yim),DF;2file sequence EPR

LK2.01.DC;Erase

[Execution Sequence]

EXT1 key = Continuous programming of two YIM folders, EXT2 key = Executing Erase

When you press "EXT1" key, "SAMPLE.YIM" is downloaded as Current IMPRESS Module, and EPR is performed to the target with the contents of it.

Then, "SAMPLE_2.YIM" is loaded as Current IMPRESS Module, and EPR is performed to the target with the contents of it.

When press "EXT2" key, the flash memory of the target will be executed Erase.

[Usage example]

You can program into both an internal flash and external flash, when the circuit board whose flash microcomputer is connected with the external flash memory.

11. YCM File

YCM file is a file to do the following settings automatically when starting up NETIMPRESS avant.

Ethernet settings (IP address, port, subnet mask, gateway address setting)

VCC terminal (5V) output control setting



The above settings can be changed by NETIMPRESS avant operation. See the manual "NETIMPRESS avant operation manual" for operation procedure.

11.1. YCM File Format

YCM file can be created by text file format. Enter a command code of the command what you want to execute by text editor. Refer the list below.



The name of the YCM file is arbitrary (Kana and some symbols are not available), but please save it with an extension (.YCM).

Only one YCM file can be placed in the root directory of the SD card.

Command definition list

Command Code	Description
[ETHER NET]	Ethernet settings (IP address, port, subnet mask or gateway address) require this command.
ADDRESS=xxx.xxx.xxx.xxx	Used setting IP address. *Enter a number between 0 and 255 in the "xxx" field.
PORT=xxxx	Used to set port number. *Enter a number between 0 and 65535 in the "xxx" field.
SUBNET MASK=xxx.xxx.xxx.xxx	Used to set subnet mask. *Enter a number between 0 and 255 in the "xxx" field.
GATEWAY=xxx.xxx.xxx.xxx	Used to set gateway. *Enter a number between 0 and 255 in the "xxx" field.
VCCOUTON	Turn on 5V output of the VCC terminal
VCCOUTOFF	Turn off 5V output of the VCC terminal

(Continued on next page)



Do not describe anything other than what is defined above.

Only one command should be described per line of text file.

Each line of text file must be left-justified.

Blank lines may be inserted between commands.

Commands can be written in any order. However, to configure any of Ethernet settings, the command "[ETHER NET]" must be described first.

11.2. Creating YCM file

Example 1.) When only setting up all items of Ether net

- (Text File)-

```
[ETHER NET]
ADDRESS=192.168.0.1
PORT=1000
SUBNET MASK=255.255.255.0
GATEWAY=0.0.0.0
```

[Setting Detail]

Set IP address: 192.168.0.1

Set Port Number: 1000

Set subnet mask: 255.255.255.0

Set gateway: 0.0.0.0

Example 2) When setting some items of Ethernet and controlling output of VCC terminal

- (Text File)-

```
[ETHER NET]
ADDRESS=192.168.0.1
SUBNET MASK=255.255.255.0

VCCOUTON
```

[Setting Detail]

Set IP address: 192.168.0.1

Set subnet mask: 255.255.255.0

5V is output from VCC terminal.

11.3. How to use YCM file

- a. Create YCM file in advance.

➤ Please refer to Chapters 11.1~11.2 of this manual for information on how to create YCM file.

- b. Copy YCM file to the root directory of the SD card.

Only one YCM file may exist.

If the file is copied to a location other than the root directory, it will not be recognized correctly.

- c. Insert the SD card into NETIMPRESS avant main unit and turn the power ON.

- d. The LCD will display "YCM DATA SET ?", press the [SET] key if you want to set the data with the contents YCM file, or press the [QUIT] key if you do not want to set the data.



Commands for VCC control processing are executed automatically regardless of the key pressed.

- a. IP address and other information will be displayed on the top screen after startup.

Then Ethernet setup is completed.

After the Ethernet settings are completed, you can communicate with the software for writer control: Remote Controller (SWX600).



Ethernet settings and VCC terminal control settings can also be changed by operating the main unit. Please refer to the separate "NETIMPRESS avant Operation Manual" for the operation method.

12. Glossary

Words & Terms	Description
SD card	Insert this dedicated SD card into NETIMPRESS avant main unit. This dedicated SD card is necessary for operating the main unit. By installing object files and other necessary files into a YIM folder in a SD card, you can operate NETIMPRESS avant as a stand-alone.
Buffer memory	NETIMPRESS avant has a buffer memory whose memory map is same as the programming target MCU in the each YIM folder of dedicated SD card. When the flash memory programming, data in the buffer memory is programmed into MCU.SWX600 can load / save an object file in the buffer memory, edit the buffer memory, etc.
Definition program	MCU-specific program to communicate each MCU. This is placed in the each YIM folder of the dedicated SD card. Some parts of the definition program are consisted from parameter. You can change it by using a remote controller SWX600. (To use the definition program, you need to install definition license in each dedicated SD card.)
Probe logic license	AFX is provided with probe cables, PHX400 and PHX. PHX400 supports serial and SPI by default. You can expand supported interface by adding a probe logic license.
Object file	This is the program / data file for programing into the flash memory of microcomputer by the user. NETIMPRESS supports the binary, intel HEX, and Motorola S format.
Programming control program	Software for rewriting the flash memory on MCU. NETIMPRESS air communicates with a boot program of MCU, and downloads data to RAM of MCU. The programming control program (extension .BTP) has to be in the YIM folder in the SD card.
WCP	This is an abbreviation of Write Control Program.
BTP file	It means a programming control program file (extension .BTP).
Current file	Current file means a file name of currently loaded object data. File name of the current file is set when downloading the object.
AMK file	AMK file is a file for sending a specific ID code, which does not vary depending on the object data, to MCU which has a security function. AMK file is included with the Micom-pack. The file format is Motorola S, which comes with an encrypted address and dummy data (FF). The data can be changed by using a file generator (AZ481).



NETIMPRESS avant START-UP MANUAL

DTS INSIGHT CORPORATION

URL: https://support.dts-insight.co.jp/en/product/support_netimpress/

5th Edition published on June 6th, 2025

© 2025 DTS INSIGHT CORPORATION. All rights reserved.