

NETIMPRESS *avant*

NETIMPRESS *avant*

OPERATION MANUAL

DTS INSIGHT CORPORATION

Revision History

Edition	Date of Issue	Modifications
1st Edition	2019.03.15	Initial publication
2nd Edition	2019.06.26	Description of Answerback function is added
3rd Edition	2019.11.29	Correction of erroneous description
4th Edition	2020.09.04	Error code is added.
5th Edition	2022.02.15	VCC Output Function is added
6th Edition	2022.12.29	Modification of partial description

Note

- (1) No part of this manual may be reproduced or transmitted in any form or by any means, electronic or mechanical, without the written permission of DTS INSIGHT CORPORATION.
- (2) The contents of this manual are subject to change without prior notice due to improvement of the functionality.
- (3) If any question about the contents of this manual arises, contact DTS INSIGHT CORPORATION.
- (4) DTS INSIGHT CORPORATION shall not be held responsible for direct or indirect adverse effects resulting from operation of this system irrespective of the above item (3).
- (5) Product and company names mentioned in this manual are the trademarks of their respective owners.

Introduction

“NETIMPRESS avant Operation Manual” (hereinafter called this manual) describes AFX100 stand-alone operation. When you want to operate NETIMPRESS avant with a PC, see SWX600 SOFTWARE MANUAL.

-  The wording “Programming” in this manual means writing data into a target microcomputer flash memory or an external flash memory connected to the target microcomputer.

The following table describes the meaning of icons used in this guide.



It indicates very important information. Be sure to perform an operation with extra care.



It indicates useful information and tips for operation.





It indicates references. Please see the referenced chapter of this manual and other manuals, if you needed.

For Your Safety

In order to ensure the proper and safety use of NETIMPRESS avant, please be sure to follow the safety precaution mentioned below as operating NETIMPRESS avant. DTS INSIGHT CORPORATION has no responsibility or guarantee for any injuries which occur as a result of the violation of these safety caution and warnings.

This manual uses the icons as below to use NETIMPRESS avant safety.

	It indicates not only that there is a danger to human as well as to the equipment, but also that it is necessary to refer to the instruction manual.
	It indicates a safety ground terminal. As this terminal is on the main unit, please be sure to connect this terminal to the ground before operating.
Warning	In order to avoid the risk of death or serious injury which may occur as a result of an incorrect use.
Note	In order to avoid the risk of minor injury or material damage which may occur as a result of an incorrect use.

■ To avoid the risk of death or serious injury to users, such as electrocution or any other accidents, as well as the risk of damage to NETIMPRESS avant, please follow the warnings mentioned below.



Warning

Use in Chemical Gases

Do not use NETIMPRESS avant in an environment where are combustibile or explosive gases or steam. Using NETIMPRESS avant in such environment is extremely dangerous.

Usage environment

This programmer is only for indoor use. Use it at an altitude of 2000 meters or less.

Available voltage range and power-supply frequency must not exceed the rated voltage $\pm 10\%$, 50/60 Hz ± 2 Hz.

We are assuming NETIMPRESS avant will be used under Overvoltage category II and Pollution Degree

Install it around an electric outlet so that you can unplug it to shut down the power easily.

Power

Confirm that the supply-side voltage matches to the rated power supply voltage for a power supply pack of NETIMPRESS avant.

Use the AC cable provided with NETIMPRESS avant to ensure safe operation.

Do not use damaged AC cable.

Do not remove the case

Only qualified service engineers should remove the case of NETIMPRESS avant because of the high voltage.

Only qualified service engineers should remove the case of Flash Programmer because of the high voltage.

Action to be taken if abnormality is found

If any failure is found, such as smoke or burnt odor, disconnect NETIMPRESS avant and the target probe, and then turn off the power of NETIMPRESS avant. Contact the support center of DTS INSIGHT Corporation.

NETIMPRESS avant is an electronic device which consists of high-precision electronic components. Please be sure to understand and follow the caution listed below in order to avoid any accidents and as well as to make the most of your NETIMPRESS avant.

CAUTION

Power On Sequence

Make sure to follow the switch ON/OFF order of each way of a host computer, NETIMPRESS avant, and a target system.

The Switch ON / Switch OFF sequence should be followed in order to avoid major damages to a target system and NETIMPRESS avant itself.

Power On Sequence

- ① Host computer
- ② NETIMPRESS avant
- ③ Target system

Power Down Sequence

- ① Target system
- ② NETIMPRESS avant
- ③ Host computer

Connecting the Probe and Connector

All probes and cables are designed to prevent an incorrect connection. Never force them to plug in nor unplug. Confirm the position and direction.

Disassembling NETIMPRESS avant

Since NETIMPRESS avant contains printed circuit boards with minute patterns, never remove screws or disassemble NETIMPRESS avant.

If the product is disassembled or modified by the user, it will not be covered under the warranty or support services.

Neutralization

Make sure to neutralize the charge before operating NETIMPRESS avant.

EU Directive

CE Marking

Item	Compliant standards
CE Marking *1 	[EMC Directive] Emissions: EN61326-1 Class A Immunity: EN61326-1 Table 2 (for use in industrial locations) [RoHS Directive] EN50581:2012

*1 The product in which CE Marking is indicated on the product serial label is a target.

CAUTION

This instrument is a Class A product, and it is designed for use in the industrial environment. Please use this instrument in the industrial environment only.

Waste Electrical and Electronic Equipment Directive (2012/19/EU)



Waste Electrical and Electronic Equipment Directive (WEEE) is for EU countries.

NETIMPRESS avant complies with WEEE Directive (2012/19/EU). Electric/electronic products carrying this mark must be disposed of separately from normal household wastes.

Product category

With reference to the equipment types in the WEEE directive Annex 1, this product is classified as a "Monitoring and Control instrumentation" product. When disposing products in the EU, contact your local distributor. Do not dispose in domestic household waste.

IMPORTANT

Thank you for your purchasing "NETIMPRESS avant".

To make the most of NETIMPRESS avant, please read and understand this manual and NETIMPRESS avant Startup Manual before use. After reading this manual, please keep it for the further reference whenever required. Please ensure that NETIMPRESS avant should be used only by persons who have read and understood the manuals. We strongly recommend that the first-time users receive a proper instruction from those who have a good knowledge of NETIMPRESS avant.

NETIMPRESS avant refers to NETIMPRESS avant main unit and other related products manufactured by DTS INSIGHT Corporation. A target system and the host computer are strictly excluded.

NETIMPRESS avant is an electronic device which consists of high-precision electronic components. In order to make the most of NETIMPRESS avant and also to prevent any accidents, please follow the caution listed below.

A certain repair fee is required regarding the equipment damages resulted from an incorrect use or connection, etc. Please aware that it may require a few months for repairs.

Regarding software products and manuals, DTS INSIGHT Corporation guarantees only if there are any damages of media provided by DTS INSIGHT Corporation or manual defects.

If proved that there are failures or that there are problems apart from those listed above, the action will be taken based on the maintenance agreement.



Warning

Before Switching ON the power supply, be sure to confirm whether the direction of Pin 1 in the probe tip matches to Pin 1 Socket in a target system.

An incorrect connection may result in an explosion or ignition of NETIMPRESS avant or a target system.

CAUTION

As particular parts of electronic circuits in the probe and cable tip are exposed, NETIMPRESS avant should be used only in environments where are protected from a static electricity.

Using NETIMPRESS avant in such environment as without static electric protection may result in destroying NETIMPRESS avant or a target system.

Table of Contents

FOR YOUR SAFETY	3
EU DIRECTIVE	6
IMPORTANT	7
1. AFX100	11
1.1. NETIMPRESS avant (AFX100) Description	11
1.1.1. Keys	11
1.1.2. Start window	12
1.1.3. Basic operation	12
1.2. Functions	13
2. MENU	18
2.1. Page 1	18
2.1.1. EPR	18
2.1.2. ERASE	19
2.1.3. BLANK	19
2.1.4. PROGRAM	20
2.1.5. READ	20
2.1.6. COPY	21
2.2. Page 2	22
2.2.1. FOLDER SELECT	22
2.2.2. FOLDER DELETE	23
2.2.3. FOLDER COPY	23
2.2.4. FOLDER PROTECT	24
2.2.5. FOLDER SAVE	24
2.3. Page 3	25
2.3.1. PROGRAMMING AREA	25
2.3.2. TVCC THRESHOLD	25
2.3.3. WDT SETTING	26
2.3.4. TGT FREQUENCY	26
2.3.5. VERIFY MODE	26
2.3.6. SUM MODE	27
2.4. Page 4	28
2.4.1. BAUDRATE SETTING	28
2.4.2. PROBE SELECT	28

2.4.3. I/F SELECT	29
2.4.4. MCU MODE	29
2.4.5. WARNING DISP:LOAD	29
2.4.6. WARNING DISP: AREA	30
2.5. Page 5	31
2.5.1. FILE -> BUFFER(LOAD)	31
2.5.2. BUFFER -> FILE(SAVE).....	31
2.5.3. BUFFER CLEAR.....	32
2.5.4. BUFFER AREA.....	32
2.5.5. BLOCK STORE	32
2.6. Page 6	33
2.6.1. SUM CALC	33
2.6.2. YSM FILE CHECK	33
2.6.3. UPLOAD FORMAT	34
2.6.4. RAM DISK AREA.....	34
2.6.5. BUF ENCRYPT.....	34
2.7. Page 7	35
2.7.1. FILE DELETE (FOLDER)	35
2.7.2. FILE DELETE (ROOT)	35
2.7.3. FORMAT(SD)	36
2.7.4. FREE DISK SPACE(SD)	36
2.7.5. PARAMETER SAVE	36
2.7.6. PARAMETER LOAD.....	37
2.8. Page8	38
2.8.1. ADD LICENCE.....	38
2.8.2. READ LICENCE	39
2.8.3. VERSION.....	39
2.8.4. SERIAL NUMBER.....	40
2.9. Page9	41
2.9.1. LOG ON/OFF	41
2.9.2. LOG DELETE	41
2.10. Page10	42
2.10.1. FIRM UPDATE.....	42
2.10.2. FPGA UPDATE.....	43
2.11. Page11	44
2.11.1. DI FILTER.....	44

2.11.2. LCD BACKLIGHT	44
2.11.3. TGT VCC (5V) ON/OFF.....	45
2.12. Page12	46
2.12.1. IP ADDRESS	46
2.12.2. SUBNET MASK	46
2.12.3. GATEWAY	47
2.13. Page13	48
2.13.1. CM FUNCTION.....	48
3. EXT KEYS.....	49
3.1. CSB File	50
3.1.1. Overview	50
3.1.2. CSB File format.....	50
3.1.3. Example of Creating CBS File	51
3.2. YMN File.....	53
3.2.1. Overview	53
3.2.2. YMN File Format.....	53
3.3. Device command definition	54
4. BARCODE CONTROL (RS232C).....	54
5. DIO CONTROL	68
6. ANSWERBACK CONTROL	72
6.1. Control Flow	72
7. LIST OF ERROR CODES.....	74
8. CONTACT	85

1. AFX100

In this chapter we describe an overview of the NETIMPRESS avant's functions and operating procedures.

1.1. NETIMPRESS avant (AFX100) Description

1.1.1.Keys

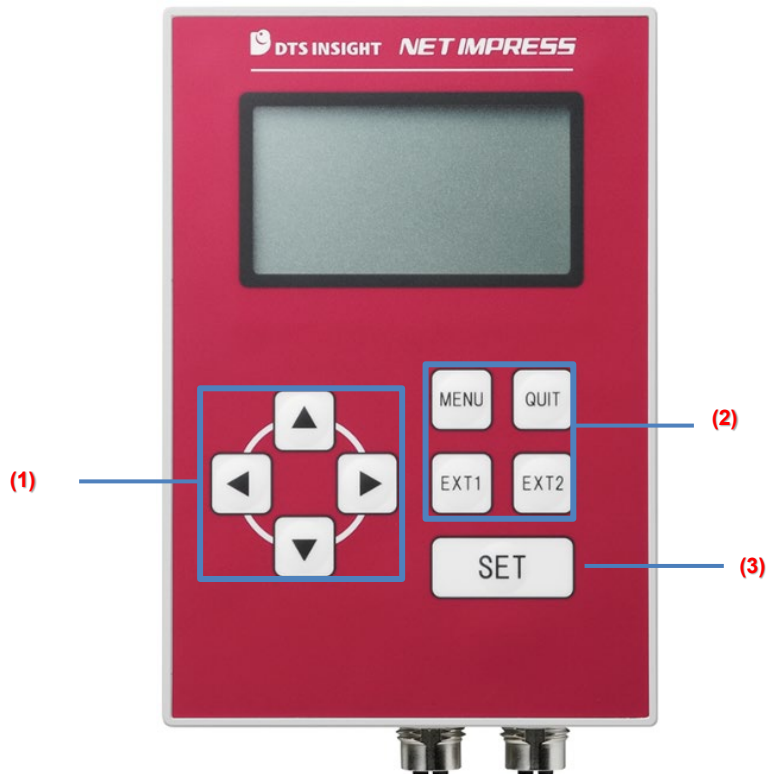

1. Use these keys to change values or choices. (In this manual we use ▲▼▶◀ depending on directions to press.)
2. - MENU ... Shows MENU screen. (Called "MENU key".)
- QUIT ... Cancels an operation. (Called "QUIT key".)
- EXT1 ... Extended key.
 You can assign this key a command sequence operation. (Called "EXT1".)
- EXT2 ... Extended key.
 You can assign this key a command sequence operation. (Called "EXT2 key".)

➡ For the details of EXT keys, see 3. EXT Keys and CSB Files.

3. Mainly Use this key to settle something. (Called "SET key".)

1.1.2. Start window

Display changes to the following after the system is ready. (The information on the screen varies depending on the use condition.)

➡ When an error is shown, see the error code list starts from page 67.

```
TEST00001
FRX830
FRX830Mxx
-----
IP:192.168. 0. 1
```

* Line 1 to 3 are shown when current YIM folder is selected.

Line 1 ... Shows the name of current YIM folder.

Line 2 ... Shows a character string designated as MCUTYPE of a parameter.

Line 3 ... Shows a name of a Micom pack.

Line 5 ... Shows an IP address.

1.1.3. Basic operation

MENU screen

1. Press MENU key to open MENU screen.
2. ◀ or ▶ key takes you to the next page. (There are 13 pages for each main function.)
You can select items in the pages by pressing ▲ or ▼.
3. Press SET key to navigate to the function screen that you specified with a cursor.

➡ (For the details of the functions and those operation procedures, see 1.2. Functions and 2. MENU Operation.)

1.2. Functions

➔ When an error is shown on command execution, see the error code list starts from page 67.

[MENU Item List]

Page 1 / DEVICE FUNCTION ➔ See 2.1.Page 1.	
Menu display	Description
E.P.R	Performs Erase → Blank check → Program → Verify
ERASE	Performs Erase → Blank check
BLANK	Performs Blank check
PROGRAM	Performs Program → Verify
READ	Performs Verify
COPY	Makes a copy of the contents of a flash memory to buffer memory and verifies it.

※ The contents of DEVICE FUNCTION command may vary from the above behaviors depending on definition programs.

For further information, see a manual of each definition program.

Page 2 / FOLDER ➔ See 2.2.Page 2.	
Menu display	Description
FOLDER SELECT	Sets a selected YIM folder to the current YIM folder.
FOLDER COPY	Makes a copy of the current YIM folder.
FOLDER PROTECT	Sets protection of current YIM folder (Sets the folder attribution to Read Only.)
FOLDER SAVE	Sets current YIM folder to save or not to save.

Menu display	Description
PROGRAMMING AREA	Sets area (address) for programming or verifying.
TVCC THRESHOLD	Sets a minimum operating voltage for a target system.
WDT SETTING	Sets clock period that is output from PHXxxx WDT signal.
TGT FREQUENCY	Sets an operation frequency for a target system.
VERIFY MODE	Sets SUM / FULL of verification.
SUM MODE	Sets a desired SUM value calculation method (8/16-bit addition) and display method (8/16-bit).

Menu display	Description
BAUDRATE SETTING	Sets a baud rate corresponding to I/F SELECT.
PROBE SELECT	Selects which probe you use.
I/F SELECT	Sets a communication I/F between NETIMPRESS avant and a target system.
MCU MODE	Sets modes specific to definition programs. (For further information, see a manual of each definition licence.)
WARNING DISP:LOAD	Sets WARNING display ON or OFF when an address out of a flash target is included on object loading.
WARNING DISP:AREA	Sets WARNING display ON or OFF when PROGRAMMING AREA is different from whole area of target flash at starting up NETIMPRESS avant or at folder selection.

Page 5 / BUFFER 01  [2.5.Page 5](#)

Menu display	Description
FILE → BUFFER(LOAD)	Copies a file in a current folder to a buffer memory.
BUFFER → FILE(SAVE)	Saves information in the buffer memory to a file in a current YIM folder.
BUFFER CLEAR	Clears a buffer memory.
BUFFER AREA	Sets an address range when loading and saving the object file.
BLOCK STORE	Specified range of the buffer memory is programed in 1 byte data as desired.

Page 6 / BUFFER 02  [2.6.Page 6.](#)

Menu display	Description
SUM CALC	Displays SUM value of a buffer memory.
YSM FILE CHECK	Calculates a checksum by using YSM file.
UPLOAD FORMAT	Specifies the format when uploading a buffer memory from S record or Intel Hex
RAM DISK AREA	Specifies RAM DISK starting address and size.
BUF ENCRYPT	Sets On or Off of encryption for a buffer memory.

Page 7 / FILE,SD  [2.7.Page 7.](#)

Menu display	Description
FILE DELETE(FOLDER)	Deletes specified file in current YIM folder.
FILE DELETE(ROOT)	Deletes a file in a root directory.
FREE DISK SPACE(SD)	Shows free space of dedicated SD card.
PARAMETER SAVE	Saves current parameter setting to a file in current YIM folder.
PARAMETER LOAD	Reads a parameter file in current YIM folder.

Page 8 / LICENCE, Version  [2.8.Page 8.](#)

Menu display	Description
ADD LICENCE	Adds a licence to NETIMPRESS avant or a dedicated SD card.
READ LICENCE	Reads out a licence saved to NETIMPRESS avant or a dedicated SD card.
VERSION	Displays NETIMPRESS avant's main (FIRM) and sub (FPGA) version.
SERIAL NUMBER	Displays serial numbers of NETIMPRESS avant and a dedicated SD card.

Page 9 / Action LOG  [2.9.Page 9.](#)

Menu display	Description
LOG ON/OFF	Switches ON or OFF of command execution log executed with NETIMPRESS avant
LOG DELETE	Deletes execution log of your choice.

Page 10 / UPDATE  [2.10.Page 10.](#)

Menu display	Description
FIRM UPDATE	Updates main system (firmware).
FPGA UPDATE	Updates sub system (FPGA).

Page 11 / HARD SETTING  [2.11.Page 11.](#)

Menu display	Description
DI FILTER	Sets Digital I/O input filtering time.
LCD BACKLIGHT	Switches On and Off of the screen lighting.
TGT VCC(5V) ON/OFF	Sets VCC terminal control for PHX400 connected to NETIMPRESS avant

Page 12 / ETHER  [2.12.Page 12.](#)

Menu display	Description
IP ADDRESS	Sets an IP address
SUBNET MASK	Sets subnet mask.
GATE WAY	Sets default gateway.

Page 13 / CM FUNCTION  [2.13.Page 13.](#)

Menu display	Description
CM FUNCTION	Executes specific functions set for each definition program. See a manual of each definition program.

2. MENU

Press MENU key at a starting image, and then you can select and execute stand-alone NETIMPRESS avant's each function.

There are 13 MENU pages.

2.1. Page 1

Select a device function and execute on this page.

For contents of the performance of each device function, see the manual of the definition program.

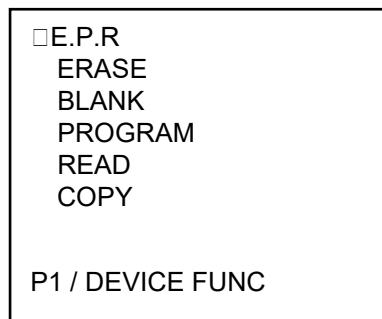

2.1.1.EPR

E.P.R executes operations in the order of ERASE, BLANK, PROGRAM, and READ.

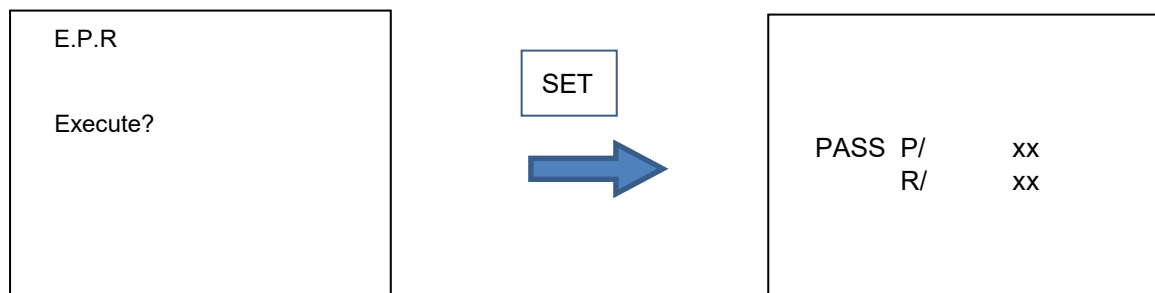

P / ... SUM value for programming

R / ... SUM value for reading

2.1.2. ERASE

Erases data of a flash memory. After erasing, this command performs a blank check and verifies erasing has been done successfully. When the flash memory is erased normally, "PASS" is displayed.

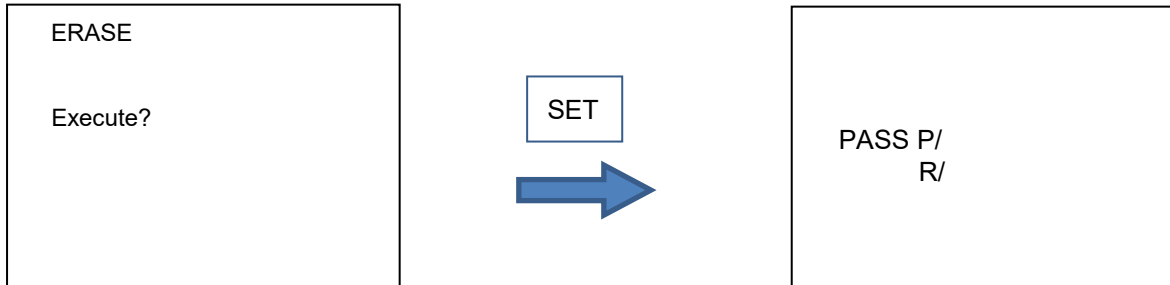

2.1.3. BLANK

Performs blank check. If the flash memory contents have been erased, "PASS" will be displayed. If not, the address that has not been erased or the top address of the erase block including that address will be displayed. The screen may show the error number and message listed on page 67 and onwards.

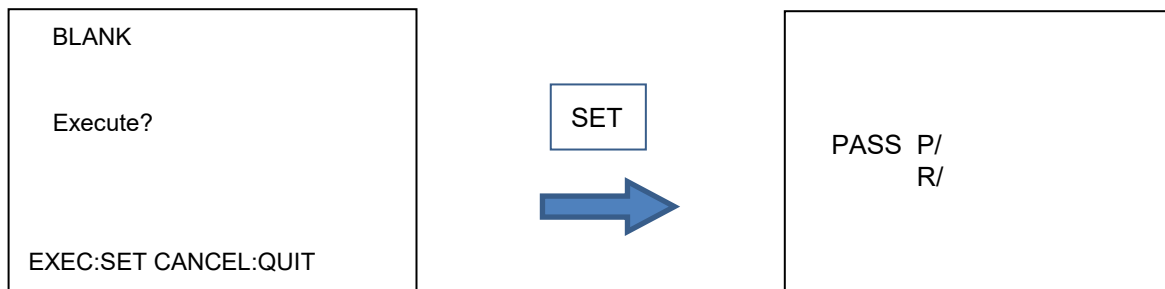

2.1.4.PROGRAM

Programs contents of buffer memory to a flash memory. If the programming is performed successfully and the buffer memory contents match with the MCU flash memory contents, "PASS" will be displayed. If not, the error address on the buffer memory will be displayed. The screen may show the error number and message listed on page 67 and onwards.

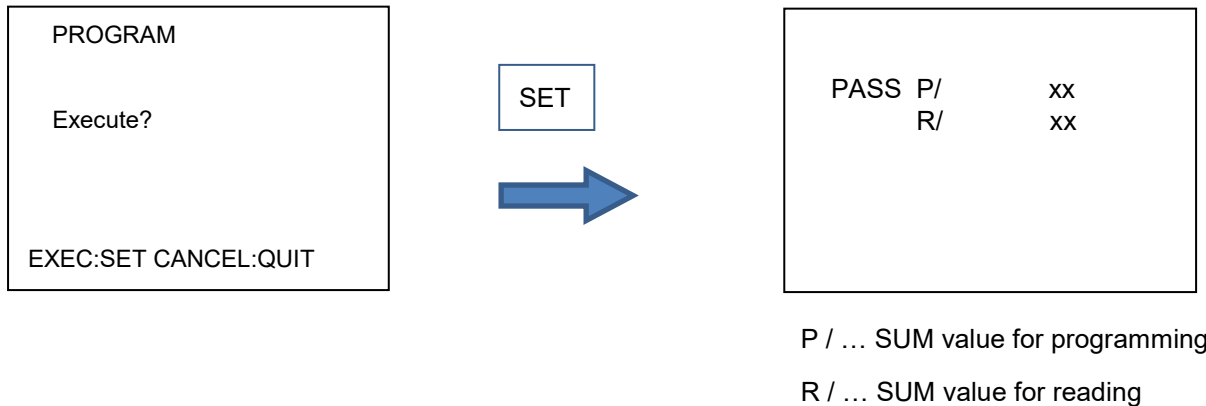

2.1.5.READ

Verifies the contents of flash memory in MCU by using NETIMPRESS avant's buffer memory data.

If the data matches, "PASS" will be displayed. If not, the error address will be displayed. The screen may show the error number and message listed on page 67 and onwards.

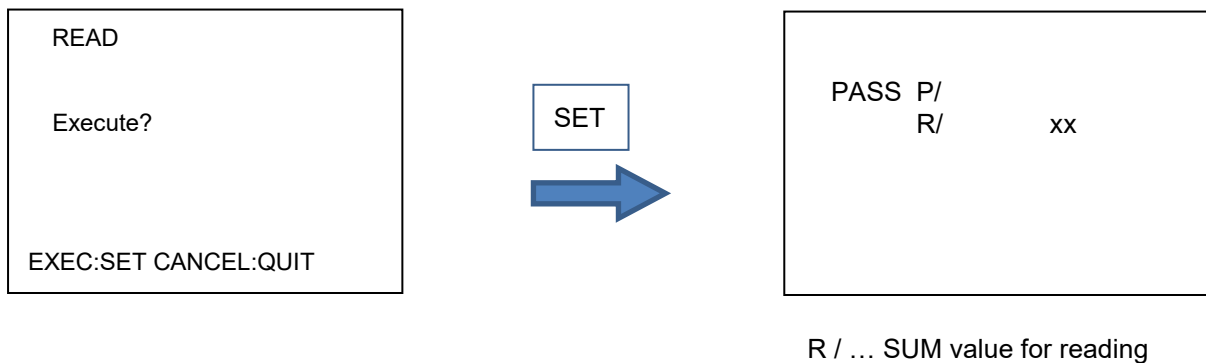

2.1.6.COPY

Copies the contents of flash memory area to buffer memory after copying, this command compares the imported contents of the buffer memory with the flash memory contents. Note that the current file is deleted when executing the COPY command. If the contents are copied successfully and they are found matching, "PASS" will be displayed. If not, the error addresses will be displayed.

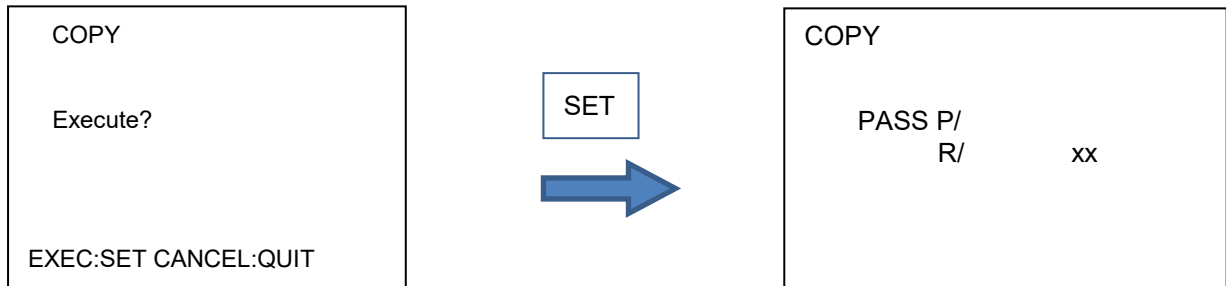

R / ... SUM value for reading

2.2. Page 2

You can manipulate YIM folders from this page. For example, you can select and delete YIM folders.

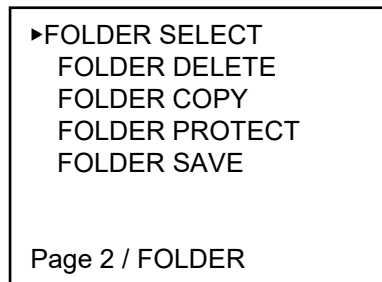

2.2.1.FOLDER SELECT

Select one of the YIM folders saved in a dedicated SD card. The folder is set as a current folder. A current folder is required to carry out programming.



You can copy a YIM folder via the card reader of PC. However, an error occurs if you select a YIM folder using the definition program licence, which is not registered for the programmer, the YIM folder cannot be set to the current folder.

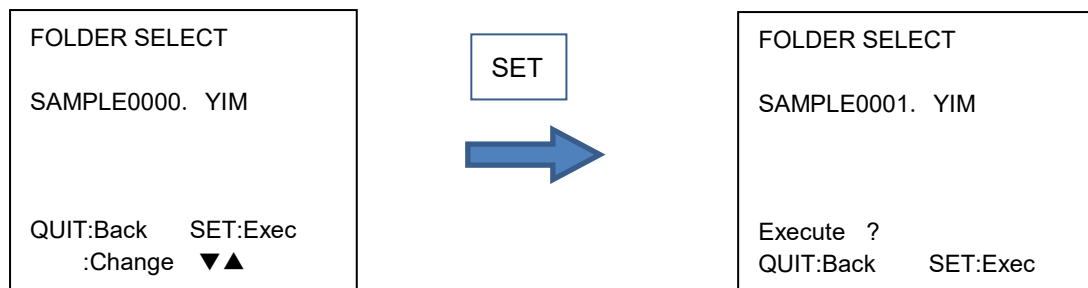

2.2.2. FOLDER DELETE

Deletes a YIM folder that you specify. When you delete the YIM folder which is set as a current folder, the setting of current folder is cleared.



Note that the YIM folder, which you delete, is not restored.

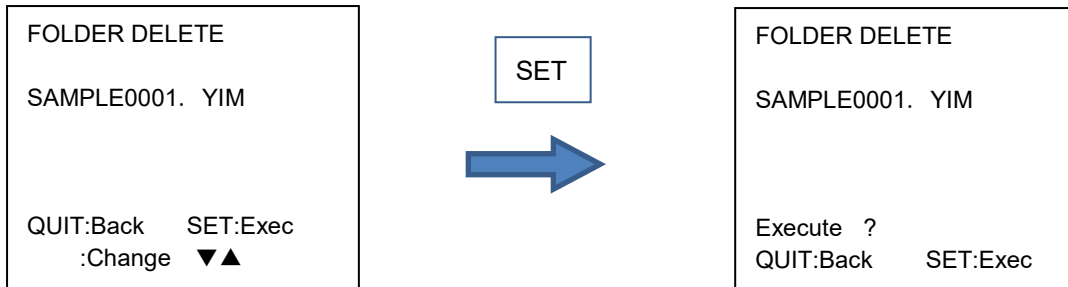

2.2.3.FOLDER COPY

Copies a current YIM folder into a dedicated SD card.

This function is used to back up the current YIM folder information.



When operating stand-alone NETIMPRESS avant, the folder is copied to the SD card with a specific name. The folder name will be shown on the LCD.

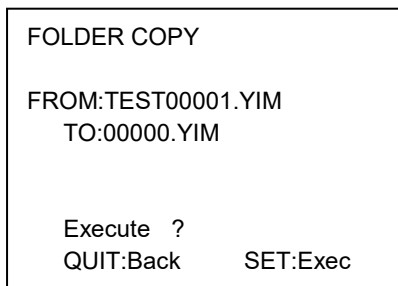

When an existing folder has the same name as the copied folder, the name of the copied folder is incremented. The name of the copied folder will be unique.

2.2.4.FOLDER PROTECT

You can set prohibition of access to current YIM folder. Use this function for controlling the access to the folder.

When you set PROTECT, the following operation is prohibited: deletion of setting folder, operation of the file in YIM folder such as copy file and file deletion, operation for buffer memory such as clearing, loading the file and saving the file.

! PROTECT is only available for stand-alone operation. When accessing a specified folder from PC via a card reader, the setting of the prohibition is ineffective.

When you set PROTECT for a current folder and change a current folder to another one, the first folder holds PROTECT setting and cannot be deleted until you set UNPROTECT to it. On the other hand, unless you set PROTECT to the new folder, it can be deleted.

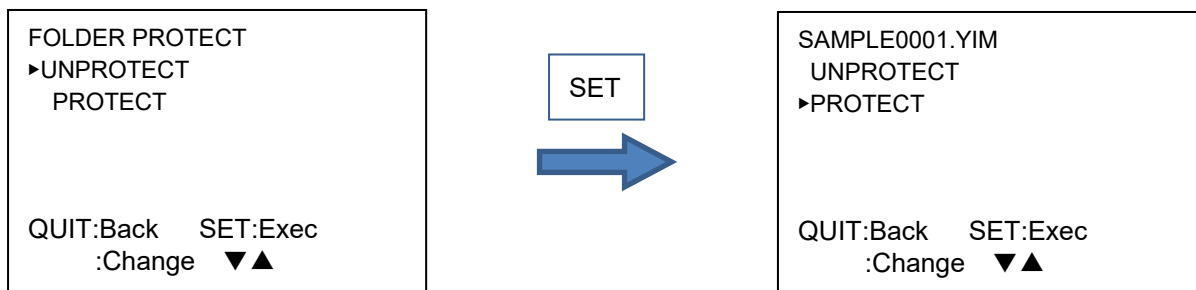

The item that ► initially points is current setting.

2.2.5.FOLDER SAVE

This function is to select if you want to keep a current folder setting from last operation for next time you start NETIMPRESS avant.

SAVE ... Current folder information is saved when you turn off NETIMPRESS avant.

NOT SAVE ... Current folder information is not saved when you turn off NETIMPRESS avant.

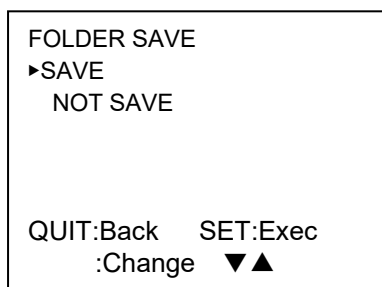

The item that ► initially points is current setting.

2.3. Page 3

Set each parameter* to execute device functions.

※ * A parameter (software parameter) that is set in a YIM folder.

```

▶PROGRAMMING AREA
TVCC THRESHOLD
WDT SETTING
TGT FREQUENCY
VERIFY MODE
SUM MODE

P3 / TARGET SUB 01
    
```

2.3.1.PROGRAMMING AREA

Set a programming area.

You can select first address and last address from block boundary addresses by pressing ▲▼▶◀ keys. (First address and last address are shown as FIRST and LAST on the screen.)

```

PROGRAMMING AREA
FIRST / LAST
00000000 / 0010FFFF

QUIT:Back  SET:Exec
▼▲:Change◄►:Cursor
    
```

2.3.2.TVCC THRESHOLD

Set the minimum operating voltage for a target microcomputer in the range of 0.1 to 4.5 V.

When the target microcomputer voltage is lower than that of you assigned, NETIMPRESS avant stops programming the target.

```

TVCC THRESHOLD
0.1[V]

QUIT:Back  SET:Exec
:Change  ▼▲
    
```

2.3.3.WDT SETTING

Set one pulse that is output from PHXxxx WDT signal in the range of 1 ms to 200 ms in units of 1 ms.

WATCHDOG TIMER _020[ms]
QUIT:Back SET:Exec :Change ▼▲

2.3.4.TGT FREQUENCY

Set a target frequency. The frequency must be between 0.1 MHz and 99.9 MHz in units of 0.1 MHz.

TARGET FREQUENCY _1.0[MHz]
QUIT:Back SET:Exec :Change ▼▲

2.3.5.VERIFY MODE

Change the method of executing verification.

NETIMPRESS avant has two verify modes.

FULL READ VERIFY: Compares the programmed data in a target device with buffer memory data.

SUM READ VERIFY: Compares the sum values received from the target device with the sum values of the buffer memory.

VERIFY MODE ▶FULL VERIFY SUM VERIFY
QUIT:Back SET:Exec :Change ▼▲

The item that ▶ initially points is current setting.

2.3.6.SUM MODE

You can change the check SUM calculation and display of the calculation result which are executed in the operations below.

- When the SUM CALC is executed from the BUFFER 02 group on the MENU.
- When SUM Check is executed from SWX600.
- When device function is executed

Calculation method (CALC) → 8-bit addition or 16-bit addition

Display method (DISP) → 8-bit display or 16-bit display

SUM CALC MODE	
<input type="checkbox"/>	CALC 8 / DISP 8
<input type="checkbox"/>	CALC 16 / DISP 16
<input type="checkbox"/>	CALC 8 / DISP 16
QUIT:Back	SET:Exec
:Change ▼▲	

2.4. Page 4

You can configure the settings for target communication and warning in this page.

```

▶BAUDRATE SETTING
  PROBE SELECT
  I/F SELECT
  MCU MODE
  WARNING DISP:LOAD
  WARNING DISP:AREA

```

P4 / TARGET SUB 02

2.4.1. BAUDRATE SETTING

Set a baud rate corresponding to I/F SELECT.

```

BAUDRATE SETTING
CSI

```

5Mbps

```

QUIT:Back  SET:Exec
:Change ▼▲

```

2.4.2. PROBE SELECT

Select a probe.

PROBE1...Probe to be used is fixed to PROBE 1

PROBE2...Probe to be used is fixed to PROBE 2

PROBESELECT... PROBE 1 and PROBE 2 are switched depending on probe select signals at a probe tip.

(When the probe select signal is ON for both PROBE 1 and 2, Probe 1 is asserted.)

```

TARGET PROBE SELECT
▶PROBE 1
  PROBE 2
  PROBE SELECT

```

```

QUIT:Back  SET:Exec
:Change ▼▲

```

2.4.3.I/F SELECT

Set a communication method with a target.

When there are more than one communication methods for your definition program or Micom Pack a definition program or Micom pack, select one method here.

I/F SELECT
CSI
QUIT:Back SET:Exec
:Change ▼▲

2.4.4.MCU MODE

Set a specific mode that is specified by a definition program.

For each mode and display item, see a manual of each definition program.

2.4.5.WARNING DISP:LOAD

Set whether you want to output a warning message in the following cases:

- When you try to load data to an area other than the buffer memory area.

WARNING DISP LOAD
▶ON
OFF
QUIT:Back SET:Exec
:Change ▼▲

The item that ▶ points is current setting.

2.4.6.WARNING DISP: AREA

When you select ON for this function, an error message "ADDRESS WARNING" is shown when [PROGRAMMING AREA] or [BUFFER AREA] is different from information of target device whole area at starting up NETIMPRESS avant or at folder selection.

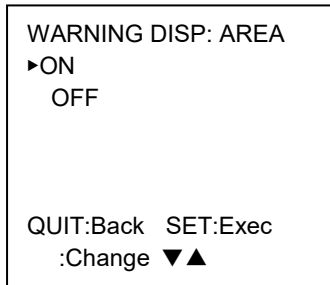

The item that ▶ points is current setting.



If you select OFF, NETIMPRESS avant does not output the warning message when the situation is as above.



When you select ON, the warning is output when the setting area of device function is partial and the downloaded object data includes the data out of the buffer memory area.

2.5. Page 5

You can operate buffer memory in this page.

▶FILE -> BUFFER(LOAD)
 BUFFER -> FILE(SAVE)
 BUFFER CLEAR
 BUFFER AREA
 BLOCK STORE

P5 /BUFER 01

2.5.1.FILE -> BUFFER(LOAD)

You can load a file saved in the current folder into buffer memory. The following formats are supported: Intel HEX, Motorola S and binary format.

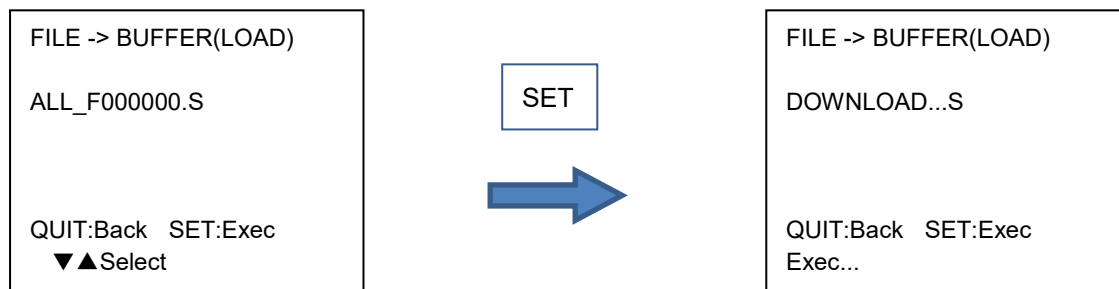

2.5.2.BUFFER -> FILE(SAVE)

Save the data in the buffer memory to the file in current folder.

This is used for making a backup of the buffer memory.

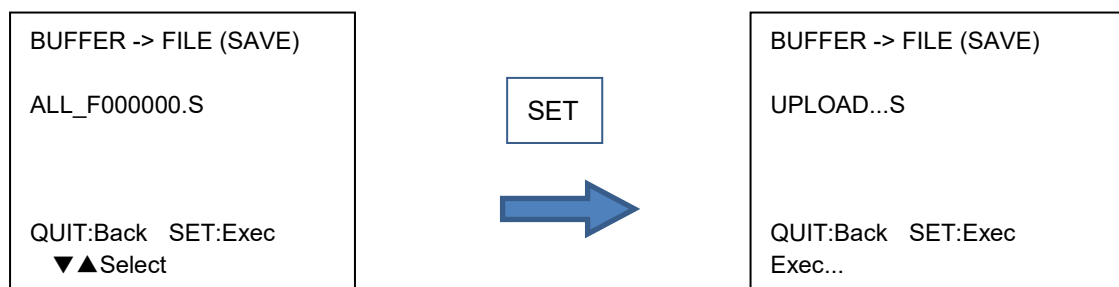

2.5.3.BUFFER CLEAR

Clear all buffer memory. (Default 0xFF)

Use this function to clear previous data for setting the new data to the buffer memory.

BUFFER CLEAR
Execute ?
QUIT:Back SET:Exec

2.5.4.BUFFER AREA

Sets an address range when loading and saving the object file. (Settable range for each value is 0 - F)

BUFFER AREA
FIRST / LAST
<u>0</u> 0000000 / 0003FFFF
QUIT:Back SET:Exec
▼▲: Change ◀▶:Cursor

2.5.5.BLOCK STORE

Programs the specified continuous area of the buffer memory in 1 byte data (Settable range for each value is 0 - F)

Set the first and last address of the area and programming data.

BLOCK STORE
FIRST / LAST
<u>0</u> 0000000 / 0003FFFF
DATA 00
QUIT:Back SET:Exec
▼▲: Change ▶◀:Cursor

2.6. Page 6

You can configure the setting about buffer memory and execute check SUM.

```
▶SUM CALC
  YSM FILE CHECK
  UPLOAD FORMAT
  RAM DISK AREA
  BUF ENCRYPT
```

```
P6 / BUFFER 02
```

2.6.1.SUM CALC

Displays SUM value of programming area and buffer memory.

```
BUFFER SUM CALC

PRG AREA SUM/ 00
BUF AREA SUM/ 00
```

```
QUIT:Back
```

2.6.2.YSM FILE CHECK

Calculates a checksum by using YSM file.

When the calculation is complete, the display is shown as follows.

```
YSM CHECK. . .
```

```
PASS
```

```
QUIT : Back
```

2.6.3.UPLOAD FORMAT

Specify the format when uploading buffer memory from S record or Hex.

After selecting a format, set a length for one record.

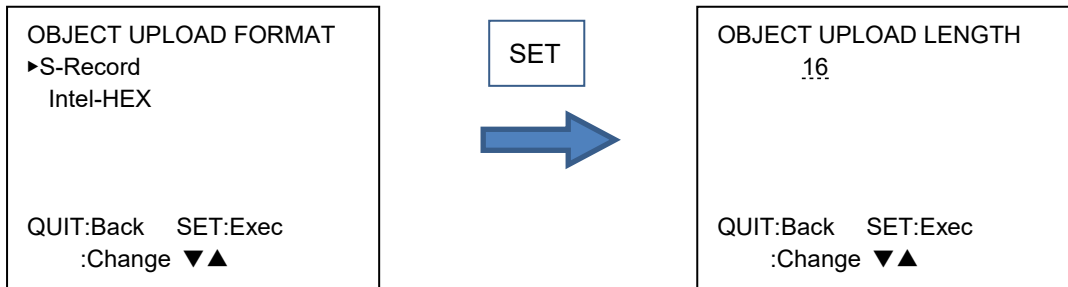

2.6.4.RAM DISK AREA

Set RAM DISK area.

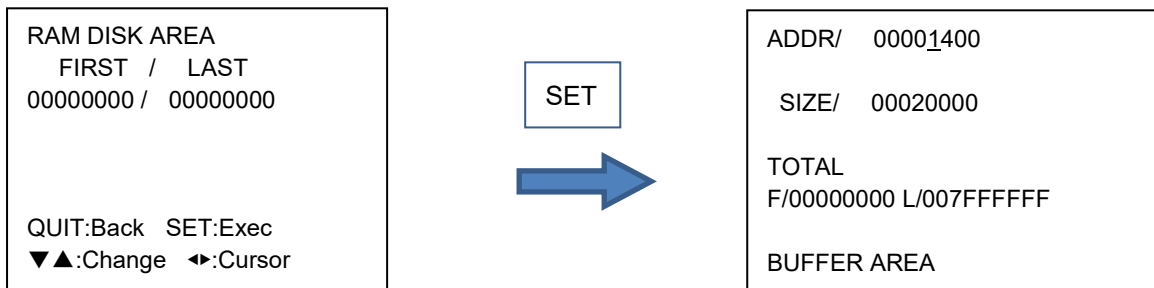

2.6.5.BUF ENCRYPT

Set ON or OFF of encryption for a buffer memory.

When you select ON for this function, buffer memory information is encrypted and saved once download to the buffer memory is executed. (Encryption is enabled only when download is executed after setting ON.)

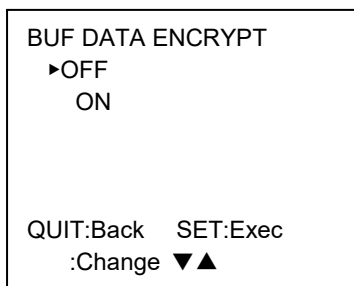

2.7. Page 7

Operate mainly about bundle files.

```

▶FILE DELETE(FOLDER)
FILE DELETE(ROOT)
FORMAT(SD)
FREE DISK SPACE(SD)
PARAMETER SAVE
PARAMETER LOAD

P7 / FILE,SD
    
```

2.7.1.FILE DELETE (FOLDER)

Delete a file of your choice in current folder.

```

FILE DELETE(FOLDER)

ALL_F000000.LCT

QUIT:Back SET:Exec
▼▲:Select
    
```

2.7.2.FILE DELETE (ROOT)

Delete a file of your choice on the root directory of the dedicated SD card.

```

FILE DELETE(ROOT)

COMMON.FWK

QUIT:Back SET:Exec
▼▲Select
    
```



```

FILE DELETE(ROOT)

COMMON.FWK

Execute ?
QUIT:Back SET:Exec
    
```

2.7.3.FORMAT(SD)

To quick format a dedicated SD card, press SET key.



When you quick format a dedicated SD card, all data are deleted.
(License information is not deleted.)

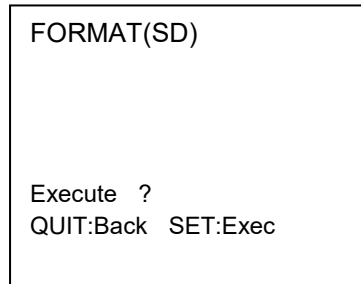

2.7.4.FREE DISK SPACE(SD)

Free space of dedicated SD card is shown here in megabyte and byte.

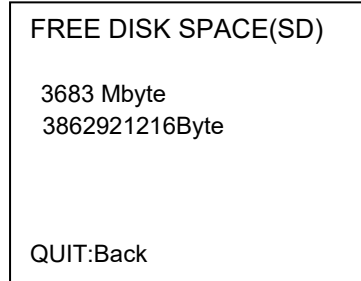

2.7.5.PARAMETER SAVE

You can back up the parameter saved in a current folder.



When you select PRM file placed in the current folder, the selected file is overwritten.

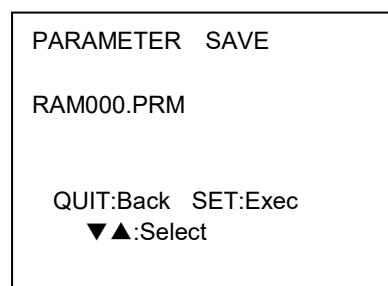

2.7.6.PARAMETER LOAD

You can modify a parameter of current folder. By placing the modified parameter in the current folder, the information of the current folder can be changed from NETIMPRESS avant as a stand-alone.



When load the parameter file in Micom-pack which differs from the parameter file currently loaded, the buffer memory clear may execute.

PARAMETER LOAD

RAM000.PRM

QUIT:Back SET:Exec

▼▲:Select

2.8. Page8

License, serial number, and version are displayed in this page.

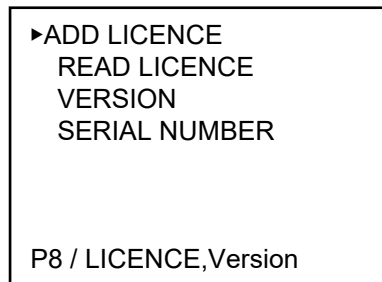

2.8.1.ADD LICENCE

You can add a licence in to a dedicated SD card by placing the licence file in a root directory of the SD card and then using ADD LICENCE function.

There are two types of licence as below.

- Definition program licence (.LCT) ... Required to use a definition program One licence is required per one dedicated SD card.
- Probe logic licence (.LCP) ... Required to use probe hardware.

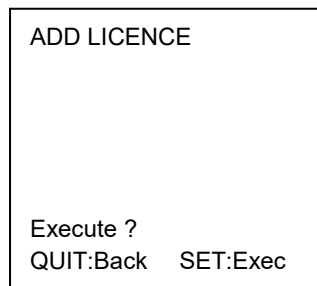

When two or more files exist in the root of the dedicated SD card, all definition licenses can be registered by executing this operation.



When the error occurs during the execution of this operation, with two or more files are placed, the definition licence is saved until immediately before the error.

2.8.2.READ LICENCE

Information of the registered definition program licence is shown.

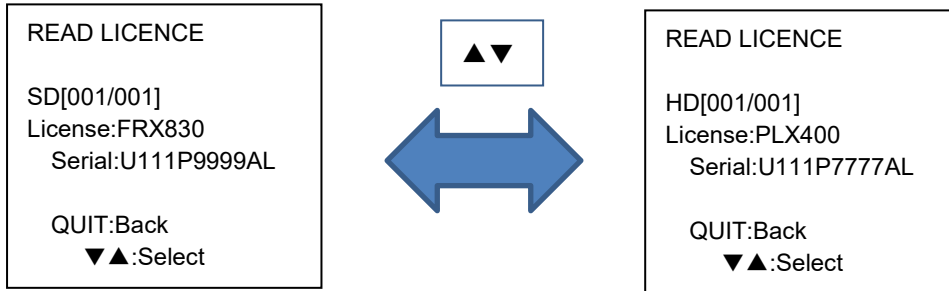

LCD: Third line	<ul style="list-style-type: none"> ● SD[YYY/XXX]: Information of definition program licence in a dedicated SD card is shown here. XXX shows the total number of the definition program licence.YYY shows the registration number of the definition program licence. ● HD[YYY/XXX]: Information of probe logic licence registered in NETIMPRESS avant. ※ YYY shows the registration number of registered order to the dedicated SD card/NETIMPRESS avant. This is not the information, particularly related to the definition program licence.
LCD: Fourth line	<ul style="list-style-type: none"> ● The name of definition program licence currently in use is shown here.
LCD: Fifth line	<ul style="list-style-type: none"> ● The serial information of the definition program licence currently in use is shown here.

2.8.3.VERSION

Displays NETIMPRESS avant's main (FIRM) and sub (FPGA) version.

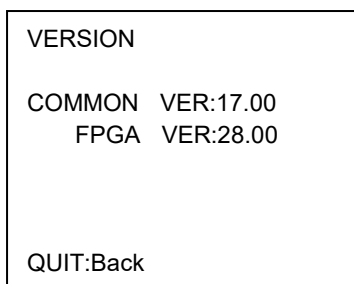

2.8.4.SERIAL NUMBER

Serial numbers of a dedicated SD card and NETIMPRESS avant are shown here. The serial numbers are needed to register a definition program licence, and when you contact us.

SERIAL NUMBER

SD:UVC13001FS
HARD:UVC14001FP

QUIT:Back

2.9. Page9

You can configure settings for command execution log. You can also delete logs.

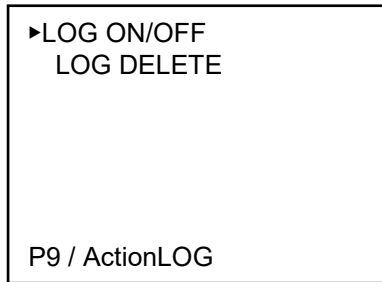

2.9.1.LOG ON/OFF

You can select if you save logs. When ON is selected, run commands and their results logs are saved.

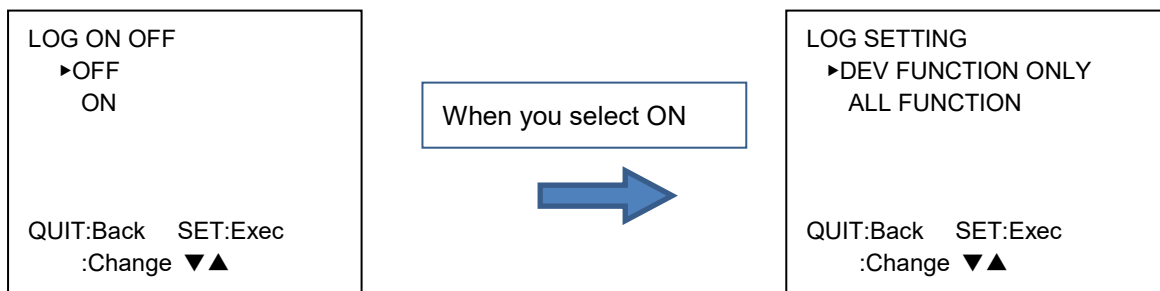

Select a function to be saved from device function only or all functions.

2.9.2.LOG DELETE

You can delete a log you chose.

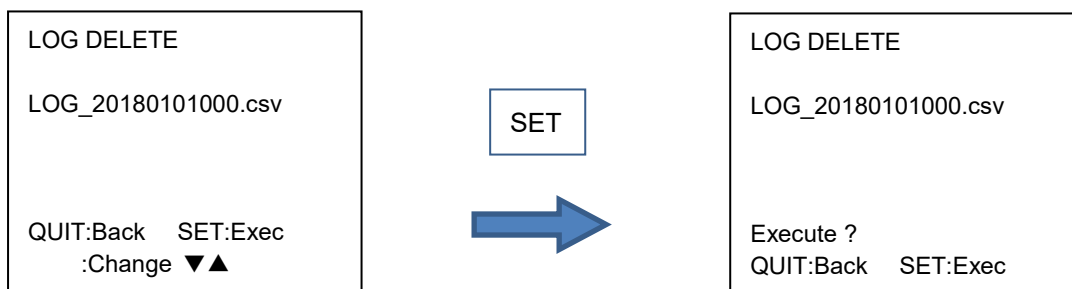

2.10. Page10

You can update various ROM data used for NETIMPRESS avant.

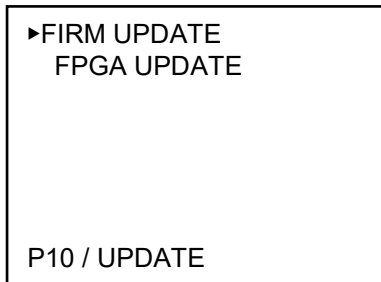

2.10.1.FIRM UPDATE

To update firmware of NETIMPRESS avant, place a firmware file (.FWK) at the root directory.

 Placing more than one firmware files causes an error.

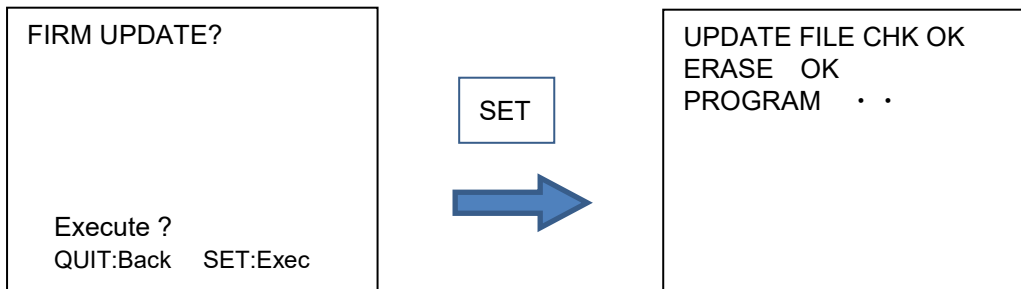

 It will take 20 to 30 seconds for executing the firmware update.

 Do not turn off the power of main unit during the firmware update.
It will result in malfunction.

2.10.2.FPGA UPDATE

To update FPGA, place a FPGA file (.HWL) at the root directory.

 Placing more than one FPGA files causes an error.

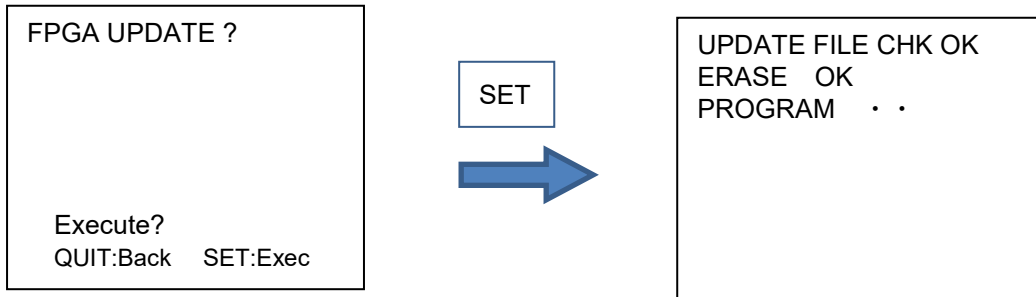

 Do not turn off the power of main unit during the firmware update.
It will result in malfunction.

2.11. Page11

▶DI FILTER
LCD BACKLIGHT

Page 11 / HARD SETTING

2.11.1.DI FILTER

To set a filtering time of Digital I/O input, specify in the range 001 [ms] to 255 [ms].by 1 [ms].

DI FILTER
010[ms]

QUIT:Back SET:Exec
:Change ▼▲

2.11.2.LCD BACKLIGHT

You can switch ON and OFF of the LCD backlight here.

LCD BACKLIGHT
▶OFF
ON

QUIT:Back SET:Exec
:Change ▼▲

2.11.3.TGT VCC (5V) ON/OFF

Set a VCC terminal output (5V) for PHX400 connected to NETIMPRESS avant.

When you enabled VCC setting, VCC terminal outputs 5V when starting up or switching this setting.

➔ For details of PHX400 VCC terminal, see the NETIMPRESS avant Flash Programmer Hard ware manual.

! During device function execution, may be controlled the VCC terminal depending on definition program.

```
VCC SETTING
▶OFF
  ON

QUIT:Back  SET:Exec
:Change ▼▲
```

2.12. Page12

You can set up NETIMPRESS avant's network environment in this page.

```
►IP ADDRESS
SUBNET MASK
GATE WAY
```

Page 12 / ETHER

2.12.1.IP ADDRESS

Set up an IP address and a port number.

```
IP ADDRESS
 192.168.  0.  2

PORT
 1000h

QUIT:Back  SET:Exec
▼▲:Change ◀▶:Cursor
```

2.12.2.SUBNET MASK

Set a subnet mask.

```
SUBNET MASK
 255.255.255.  0

QUIT:Back  SET:Exec
▼▲:Change ◀▶:Cursor
```

2.12.3.GATEWAY

Set a gateway. (Settable range is 0 - 255)

GATEWAY 0. 0. 0. 0
QUIT:Back SET:Exec ▼▲:Change ◀▶:Cursor

2.13. Page13

You can set up NETIMPRESS avant's hardware.

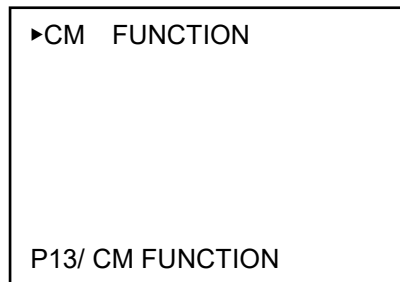

2.13.1.CM FUNCTION

For further information for each function, see a manual of each definition program.

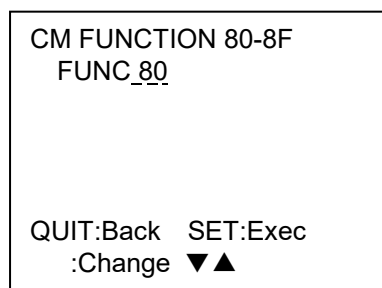

3. EXT Keys

NETIMPRESS avant has two EXT keys: EXT1 and EXT2.

You can execute multiple commands sequentially by pre-assigning a command sequence to the keys. (Up to 16 sequential executable commands can be assigned.)

A CSB file is required to assign command sequences. ➔ [See 3.1 CSB File for detail.](#)



Setup Example

EXT1

LK1,02,FB0(XXX.YIM),DF;EPR
(When you press EXT1, current YIM folder is switched to XXX.YIM folder, and EPR is executed.)

EXT2

LK2,01,DD;Program
(When you press EXT2, Program is executed.)

3.1. CSB File

3.1.1.Overview

CSB files are required to use the one-action key function(EXT key operation).



CSB File Overview CSB file is required to use the one-action key function (EXT key operation). Save file giving any name with an extension .CSB.



Only one CSB file can be placed in the root directory of a dedicated SD card. Placing more than one CSB files causes an error.

3.1.2.CSB File format

The format of CSB is as follows. Place the ',' between commands. Use a single-byte character for " , " .

$$\begin{array}{ccccccc} \underline{LK1}, & \underline{count}, & \underline{cmd1}, & \underline{cmd2}, & \dots, & \underline{cmd16}; & \underline{comment} \\ \underline{LK2}, & \underline{count}, & \underline{cmd1}, & \underline{cmd2}, & \dots, & \underline{cmd16}; & \underline{comment} \\ (1) & (2) & \underbrace{\hspace{10em}} & (4) & (5) \\ & & (3) & & \end{array}$$

(1) KEY No. code (3 bytes)

LK1 = Assignment to EXT1 key.

LK2 = Assignment to EXT2 key.

(2) count (2 bytes)

Enter how many commands are executed in a command sequence. Decimal notation is used. Therefore after "09" will be "10", and the Maximum is 16.

For unused keys, set "00".

(3) *cmd1, cmd2, ..., cmd16*:

Enter a command code of the command what you want to execute. Refer the list below.

➔ See 3.3 Definitions of Device Command for detail.



Maximum number of commands in CSB file is 16 commands.

(4) Command delimiter “;” (1 byte)

Shows the command delimiter between ③ and ⑤.

(5) Comment (Any characters + CRLF)

Describe a comment when you want to give a comment to the command. When you do not need a comment, you can finish at ④.



Make sure to write Newline (CRLF) code at the end of the line when you describe a comment.

3.1.3.Example of Creating CBS File

Example 1.

[Description]

LK1,01,DF;EPR

LK2,01,DD;Program

[Execution Sequence]

EXT1 key = Executing E.P.R., EXT2 key = Executing Program

*Precondition: YIM folder should be selected.

Example 2 :

[Description]

LK1,01,FB0(SAMPLE.yim);CHANGE YIM

LK2,01,DF;E.P.R

[Execution Sequence]

EXT1 key = Loading specified YIM folder, EXT2 key = Executing E.P.R.

When you press “EXT1” key, “SAMPLE.YIM” is downloaded as Current IMPRESS Module.

When you press “EXT2” key, EPR is performed to the target with the contents of “SAMPLE.YIM”.

Example 3 :

[Description]

LK1,04,FB0(SAMPLE_1.yim),DF,FB0(SAMPLE_2.yim),DF;2file sequence EPR

LK2.01.DC;Erase

[Execution Sequence]

EXT1 key = Continuous programming of two YIM folders, EXT2 key = Executing Erase

When you press "EXT1" key, "SAMPLE.YIM" is downloaded as Current IMPRESS Module, and EPR is performed to the target with the contents of it.

Then, "SAMPLE_2.YIM" is loaded as Current IMPRESS Module, and EPR is performed to the target with the contents of it.

When press "EXT2" key, the flash memory of the target will be executed Erase.

[Usage example]

You can program into both an internal flash and external flash, when the circuit board whose flash microcomputer is connected with the external flash memory.

3.2. YMN File

3.2.1. Overview

YMN file is a file to register a command sequence.

When you define a command code "FBD(XXXXXXXX.YMN)" in a CSB file, commands that are set to a YMN file can be executed.



More than one YMN file can be placed in the root directory of a dedicated SD card.



Maximum number of commands in YMN file is 100 commands.

3.2.2. YMN File Format

The YMN file is a text file to describe function commands you want to execute.

The following describes YMN file formatting rules.

Formatting rules

- For commands (key definitions) to be registered, use the same commands as those of the CSB file.
- Describe one command on one line.
- End each line with "CRLF".
- One line is within 256 bytes including "CRLF" (only "LF" is also permitted).
- Blank line can be used.
- Space and tab can be used between the command and comment.
- Character strings after "/" are determined as comments.

- Example of YMN file creation (text file)-

```
// TEST1. YMN
F B O (A. y i m)           //Switch to YIM folder A
D F                       //Write into the target A (E.P.R).

F B O (B. y i m)           //Switch to YIM folder B
D F                       //Write into the target B (E.P.R)
```

3.3. Device command definition

Shows the command definitions for creating CSB and YMN files.

Command definition list.

Command code	Description
F0 (XXXXXXXX YYYYYYYY)	Device function area setting (XXXXXXXX: First address, YYYYYYYY: Last address) *These settings can be omitted. When omitted them, the area will be the entire flash ROM area.
F1 (XXXXXXXX YYYYYYYY ZZ)	Block store (With this command, you can program any same data into specified range in buffer memory.) (XXXXXXXX: First address, YYYYYYYY: Last address, ZZ: data) These settings can be omitted. When omitted, the area will be the entire flash ROM area and data will be 00.
F2	Buffer memory clear
FF1 (XXXXXXXX.YYY)	Load file (XXXXXXXX.YYY: name of loading file)
FF5 (XXXXXXXX YYYYYYYY)	Transfer address setting (XXXXXXXX: First address, YYYYYYYY: Last address) These settings can be omitted. When omitted, the address becomes the entire flash ROM area.
D9	Blank (Device function)
DC	Erase (Device function)
DD	Program (Device function)
DE	Read (Device function)
DF	E.P.R. (Device function)
FB0 (XXXXXXXX.YIM)	Switching current YIM folders (XXXXXXXX.YIM: YIM folder name)
FBD (XXXXXXXX.YMN)	Execution of YMN file (XXXXXXXX.YMN: name of YMN file to be executed.)

4. Barcode Control (RS232C)

NETIMPRESS avant can be connected to a barcode reader, whose connection type is RS232C.

When you use a barcode reader, prepare the things listed below.

- BCR cable (OCX110)
- Barcode reader main unit (RS-232C connection type)
- Barcode
- YBO file

! Barcode reader can be used with the standalone environment only.

[General flowchart]

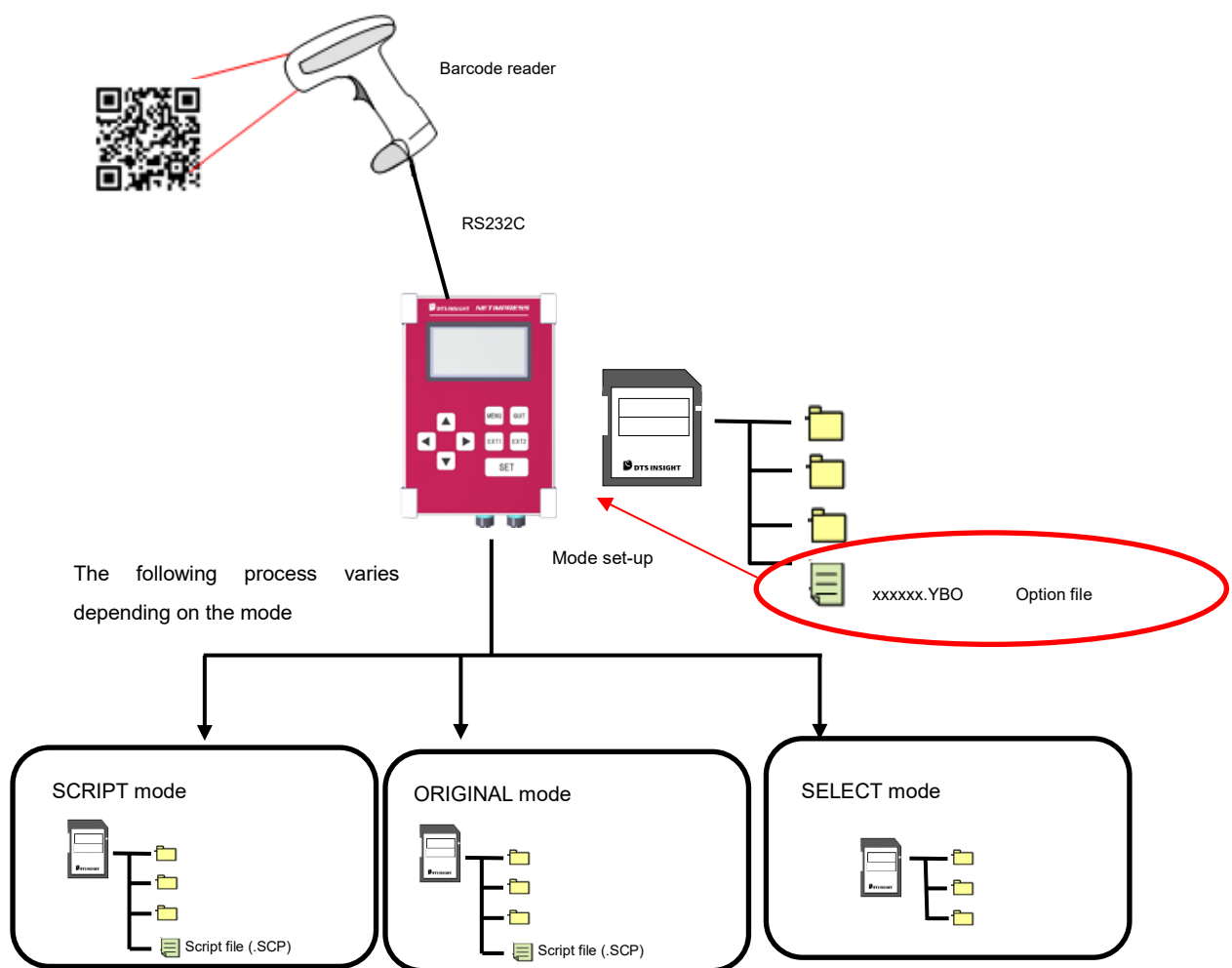

NETIMPRESS *avant* interprets received data according to each mode set in a YBO file and performs stand-alone control.

You can specify RS232C baud rate setting, a start position and end position of received data, and an end code by configuring YBO file option setting.

■ Process mode

(1) Mode which NETIMPRESS *avant* executes a script file conformed with the barcode that you

- read with a barcode reader. (SCRIPT mode)
- (2) Mode for controlling NETIMPRESS avant's main unit by reading a barcode whose format is provided by DTS INSIGHT with a barcode reader. (ORIGINAL mode)
 - (3) Mode which selects a YIM folder conformed with the barcode, and then executes the access to the target (EPR) (SELECT mode)

[Set up the Barcode reader]

To read a barcode with NETIMPRESS avant, set a barcode reader as follows.

Communication setting of the barcode reader

Baud rate	9600bps
Parity	None
Stop bit	1 stop bit
Data length	8-bit

Data format

Prefix (header)	None
Suffix (footer)	CR (0x0d)
Scan data transfer format	<data><suffix>



* For suffix information, information in the YBO file has priority in case it is specified by YBO file.

[YBO file]

- You can create and edit a YBO file with a dedicated software (AZ486).

(AZ486 can be downloaded from our home page.)

- Make sure to place a YBO file into the root of a dedicated SD card which is inserted to the programmer.
- If it is in a place other than the root directory, the barcode process becomes invalid. (The barcode cannot be received.)



Only one YBO file can be placed in the root directory of the dedicated SD card.

Barcode process becomes invalid if there is no file in the root directory or if there are more than one files in the root directory.

■ YBO file name

XXXXX. YBO

*1. You can name XXXXX part as you like.

*2. The extension must be YBO.



The extension must be written in capital letters.

■ YBO file configuration

/	/		X	X	X	X	X	.	Y	B	O			
/	/		2	0	x	x	.	x	x	.	x	x		
[M	O	D	E]									← Header
S	C	R	I	P	T									← Header
[S	E	T	T	I	N	G]						← Header
S	T	A	R	T	=	0	0	0	2					
E	N	D	=	0	0	1	2							
S	U	F	F	I	X	=	0	x	0	D				
[E	N	D]										

■ Format

1. The lines before [MODE] are treated as comments and ignored.
2. Programming order is [MODE] -> [SETTING].
3. In case there is no setting in [SETTING], it is operated as START=0, END=delimiter, SUFFIX=0x0D..
4. Make sure to place [END] at the end of the file. If there is no [END], it will become a format error.

■ [MODE]

Process mode of the barcode data is specified by the character strings described on the lines after [MODE].

You must describe these lines.

If there is no description on these lines, barcode process becomes invalid.

Header	Notation	Details
[MODE]	SCRIPT	Executes the script file conformed with the received data You do not need to describe .SCP (extension) for the barcode.
	ORIGINAL	Executes a function for the data read by the barcode reader Use the specified format
	SELECT	Selects an YIM folder conformed with data read by barcode (select only) You do not need to describe .YIM (extension) for the barcode.
	SELECT/XXXX	Selects an YIM folder conformed with data read by a barcode, and executes a device function. You can set one of ERASE, BLANK, PROGRAM, READ, EPR, or COPY You do not need to describe .YIM (extension) for the barcode.

■ [SETTING]

Effective range and end code of received barcode are set by the character strings described on the lines after [SETTING].

You can omit these settings.

Header	Argument	Description
[SETTING]	START=	Where to start the sampling: Set the starting point of the data sample Settable range: 1 to 2047 (decimal) 0x1 to 0x7FF (hexadecimal) * Enable with other than ORIGINAL mode
	END=	Where to stop the sampling: Set the end point of the data sample Settable range: 1 to 2047 (decimal) 0x1 to 0x7FF (hexadecimal) * Enable with other than ORIGINAL mode
	SUFFIX=	End code option: Set the end code of the barcode data. If there is no description, 0x0D (CR) will be the end code as default. Settable byte: 1-byte Settable character: ASCII code 0 to 127 (decimal) 0x0 to 0x7F (hexadecimal) * Enable with other than ORIGINAL mode

* If you specify SUFFIX by ASCII, enclose the characters on the following table with ' (single quotes).

Example: When specifying 0 as SUFFIX

SUFFIX='0'

■ Correspondence table of codes which can be specified as SUFFIX

Code	Character	Code	Character	Code	Character	Code	Character
------	-----------	------	-----------	------	-----------	------	-----------

DEC	HEX		DEC	HEX		DEC	HEX		DEC	HEX	
0	00	NUL	33	21	!	66	42	B	99	63	c
1	01	SOH	34	22	"	67	43	C	100	64	d
2	02	STX	35	23	#	68	44	D	101	65	e
3	03	ETX	36	24	\$	69	45	E	102	66	f
4	04	EOT	37	25	%	70	46	F	103	67	g
5	05	ENQ	38	26	&	71	47	G	104	68	h
6	06	ACK	39	27	'	72	48	H	105	69	i
7	07	BEL	40	28	(73	49	I	106	6a	j
8	08	BS	41	29)	74	4a	J	107	6b	k
9	09	HT	42	2a	*	75	4b	K	108	6c	l
10	0a	LF	43	2b	+	76	4c	L	109	6d	m
11	0b	VT	44	2c	,	77	4d	M	110	6e	n
12	0c	FF	45	2d	-	78	4e	N	111	6f	o
13	0d	CR	46	2e	.	79	4f	O	112	70	P
14	0e	SO	47	2f	/	80	50	P	113	71	q
15	0f	SI	48	30	0	81	51	Q	114	72	r
16	10	DLE	49	31	1	82	52	R	115	73	s
17	11	DC1	50	32	2	83	53	S	116	74	t
18	12	DC2	51	33	3	84	54	T	117	75	u
19	13	DC3	52	34	4	85	55	U	118	76	v
20	14	DC4	53	35	5	86	56	V	119	77	w
21	15	NAK	54	36	6	87	57	W	120	78	x
22	16	SYN	55	37	7	88	58	X	121	79	y
23	17	ETB	56	38	8	89	59	Y	122	7a	z
24	18	CAN	57	39	9	90	5a	Z	123	7b	{
25	19	EM	58	3a	:	91	5b	[124	7c	
26	1a	SUB	59	3b	;	92	5c	¥	125	7d	}
27	1b	ESC	60	3c	<	93	5d]	126	7e	~
28	1c	FS	61	3d	=	94	5e	^	127	7f	DEL
29	1d	GS	62	3e	>	95	5f	_			
30	1e	RS	63	3f	?	96	60	`			
31	1f	US	64	40	@	97	61	a			
32	20		65	41	A	98	62	b			

* For START, END, SUFFIX

- ① If you specify START=4, END=13

Characters from 4-byte to 13-byte are treated as effective data.

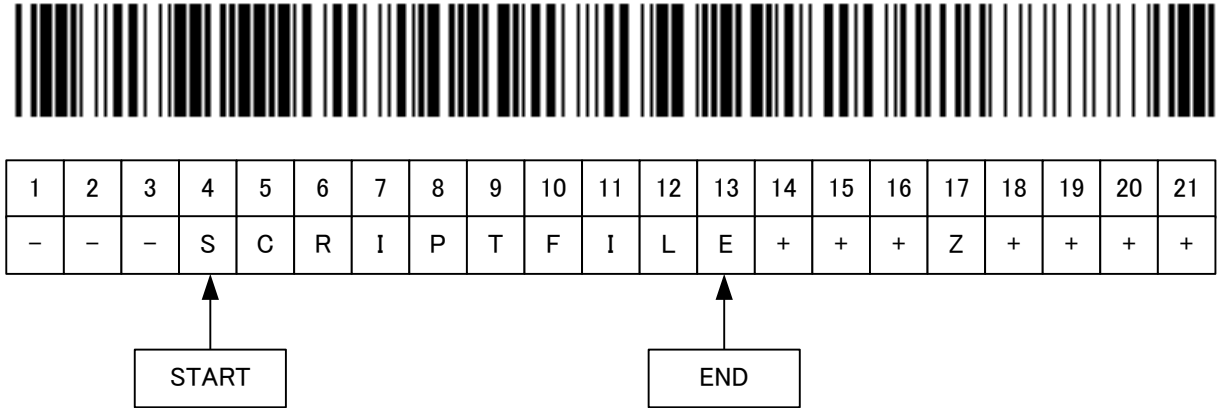

- ② If you specify START=4, END=13, SUFFIX='Z'

Programmer gets data until 16-byte (before Z: 17-byte).

Characters from 4-byte to 13-byte are treated as effective data.

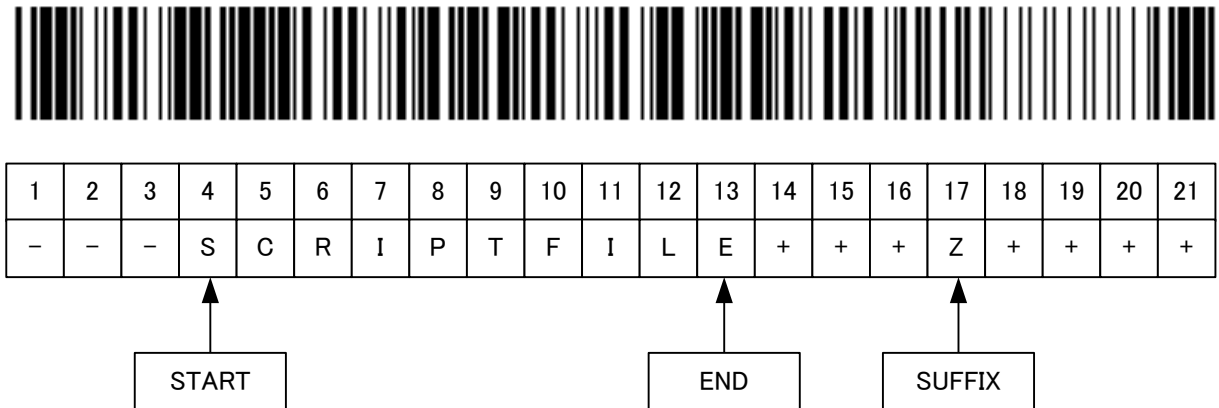

- ③ If you specify START=4, END=13, SUFFIX='Z'

Programmer gets data until 8-byte (before Z: 9-byte).

SUFFIX is placed before END, so this becomes an error.

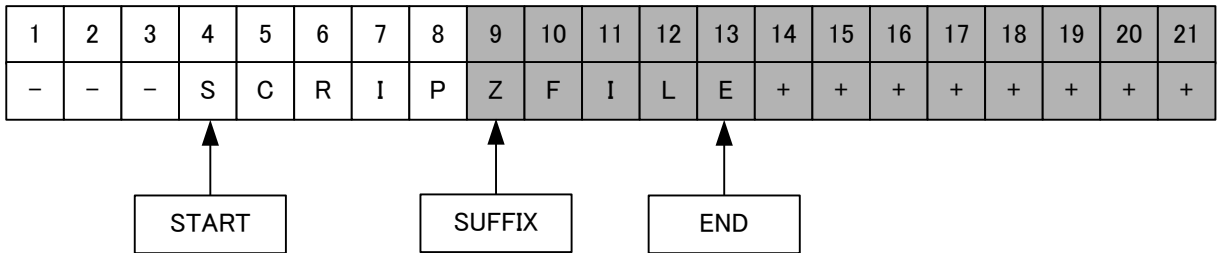

- ④ If you specify START=4, END=4

Data 'S' (at 4-byte) is treated as effective data.

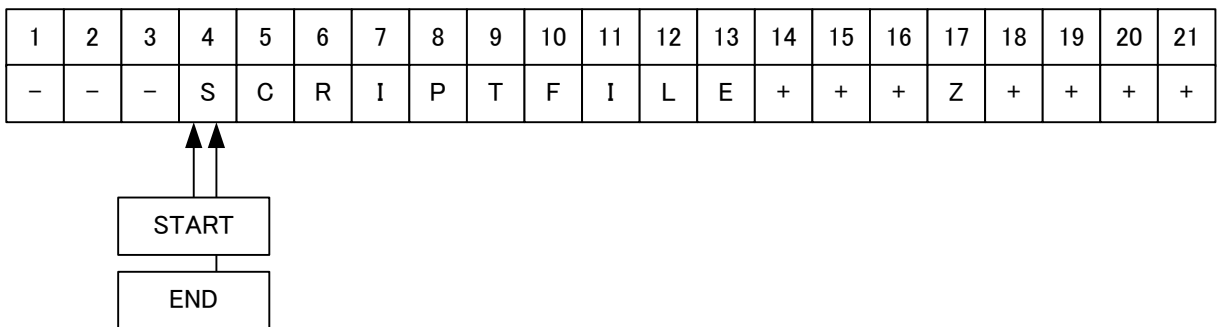

- ⑤ If you specify only START=4

Data from 4-byte to 21-byte are treated as effective data.



1	2	3	4	5	6	7	8	9	10	11	12	13	14	15	16	17	18	19	20	21
-	-	-	S	C	R	I	P	T	F	I	L	E	+	+	+	Z	+	+	+	+

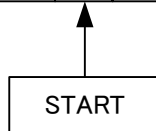

- ⑥ If you specify only END=13

Data from 1-byte to 13-byte are treated as effective data.

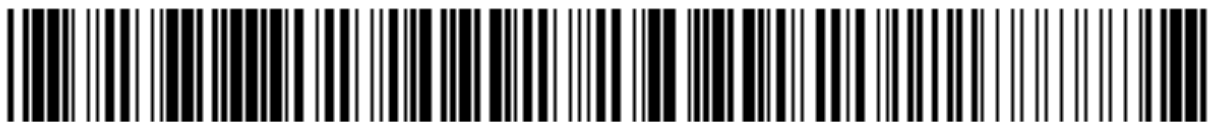

1	2	3	4	5	6	7	8	9	10	11	12	13	14	15	16	17	18	19	20	21
-	-	-	S	C	R	I	P	T	F	I	L	E	+	+	+	Z	+	+	+	+

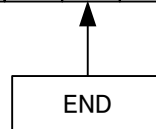

[Execution mode]

(1) SCRIPT mode

■ Overview

In this mode, NETIMPRESS avant compares script files (extension: SCP) placed in the root directory of the dedicated SD card to barcode information, and executes a matched script file.

You need to create/prepare the script files by yourself.

The barcode information to be compared is only file name. It does not include the extension.

■ Example of YBO file creation by using SCRIPT mode

[M	O	D	E]														
S	C	R	I	P	T														
[S	E	T	T	I	N	G]											
S	T	A	R	T	=	0	0	0	4										
E	N	D	=	0	0	1	3												
[E	N	D]															

Example for when YBO file is specified as above:

When the following barcode is read, NETIMPRESS avant searches a file whose name is a character string of column 4 to 13 with extension "SCR" in the root directory, and executes the script file if it is found.



1	2	3	4	5	6	7	8	9	10	11	12	13	14	15	16	17	18	19
-	-	-	S	C	R	I	P	T	F	I	L	E	+	+	+	+	+	+

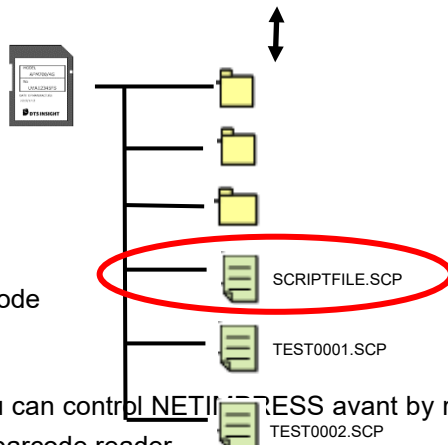

Compares the barcode data to a file name whose

(2) ORIGINAL mode

■ Overview

In this mode, you can control NETIMPRESS avant by reading a barcode created in a format provided by DTS INSIGHT with a barcode reader.

You can execute some commands in order if they are listed on the command list.

■ Example of YBO file creation by using ORIGINAL mode

[M	O	D	E]												
O	R	I	G	I	N	A	L										
[S	E	T	T	I	N	G]									
[E	N	D]													

■ Format



1	2	3	4	5	6	7	8	9	10	11	12	13	14	15	16	17
(1)	(2)	(3)										(2)				
0	2	/	F	B	0	\$	A	.	Y	I	M	/	D	F	/	/

(1) Number of commands

01 to 99 (decimal)

(2) Command delimiter

/ (fixed)

Place '/' in between commands.

(3) Command

Describe the commands.

(Place '\$' between command and argument, and in between arguments.)

(4) Delimiter (End code)

// (fixed)

End code is 2-byte

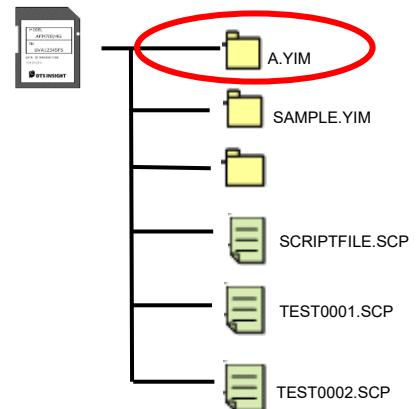

For the example barcode above, the process will be as follows:

1. <FB0\$A.YIM>: Select A. YIM
2. <DF>: Execute EPR

■ Command

The commands on the table below can be used.

Command	Meaning	Details/Example
---------	---------	-----------------

FB0	Selects module (SelectModule)	Select YIM folder/ FB0\$SAMPLE.YIM
FF1	Loads a file (LoadFile)	Buffer load of the object file FF1\$TEST.S
F2	Buffer clear (BufferClear)	Buffer clear F2
D8	Copy (Copy)	Copy/ D8
D9	Blank check (Blank)	Blank check/ D9
DC	Erase (Erase)	Erase and blank check/ DC
DD	Program (Program)	Program verify/ DD
DE	Verify (Read)	Verify/ DE
DF	EPR	Do EPR/ DF

■ Restrictions

The length of barcode (from a point where it starts receiving data to a delimiter) must be less than 0x800 (2KB).

Error occurs if it is more than 0x800.

(3) SELECT mode

■ Overview

In this mode, NETIMPRESS avant compares a YIM folder (extension: YIM) placed in the root directory of the dedicated SD card to the barcode information, and selects the matched YIM folder.

After selecting, it continuously executes a device function specified by /XXX.

■ Example of YBO file creation by using SELECT mode

[M	O	D	E]														
S	E	L	E	C	T	/	E	P	R										
[S	E	T	T	I	N	G]											
S	T	A	R	T	=	0	0	0	6										
E	N	D	=	0	0	1	2												
[E	N	D]															

Example for when YBO file is specified as above:

If you read the following barcode, it searches a file whose name is a character string of column 6 to 12 with extension "YIM" in the root directory, and selects the YIM folder if it is found.

After selecting the folder, executes EPR.



Compares the barcode data to a folder name

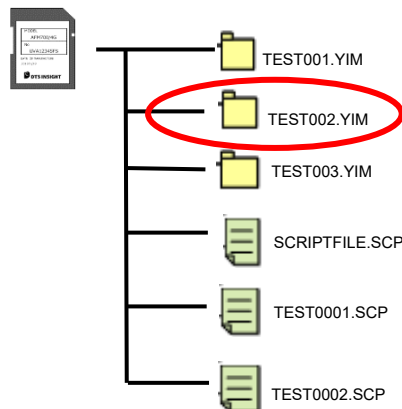

5. DIO Control

You can do the followings by digital I/O.

- Select and execute the script file
- Receive a notice of execution state of programmer (RUN signal)
- Receive a notice of state of programming to flash memory (PASS and ERR signal)
- Receive a notice of state of script execution (PASS and ERR signal)

[Script file]

Script file is an execution file which enables to control digital I/O, execute the flash programming, and select the programming type sequentially.

Create the script file by using software for creating the script file (AZ488).

< Commands which can be executed by script file >

- Folder selection
- Buffer memory clear
- File Load
- Digital I/O output OUT 0 to OUT 7
- Digital I/O input IN 0 to IN 7
- Wait designation
- Device function BLANK
- Device function ERASE
- Device function PROGRAM
- Device function READ
- Device function EPR

[Signals used for script execution]

Signal Name	definition	Script*1	I/O
Digital I/O ST0	Script selection signal 0 (Digital I/O input)	Script selection: bit0*2	I
Digital I/O ST1	Script selection signal 1 (Digital I/O input)	Script selection: bit1*2	I
Digital I/O ST2	Script selection signal 2 (Digital I/O input)	Script selection: bit2*2	I
Digital I/O ST3	Script selection signal 3 (Digital I/O input)	Script selection: bit3*2	I
Digital I/O ST4	Script selection signal 4 (Digital I/O input)	Script selection: bit4*2	I
Digital I/O ST5	Script selection signal 5 (Digital I/O input)	Script selection: bit5*2	I
Digital I/O ST6	Script selection signal 6 (Digital I/O input)	Script selection: bit6*2	I
Digital I/O ST7	Script selection signal 7 (Digital I/O input)	Script selection: bit7*2	I
Digital I/O IN0	Digital I/O input signal 0	IN0	I
Digital I/O IN1	Digital I/O input signal 1	IN1	I
Digital I/O IN2	Digital I/O input signal 2	IN2	I
Digital I/O IN3	Digital I/O input signal 3	IN3	I
Digital I/O IN4	Digital I/O input signal 4	IN4	I
Digital I/O IN5	Digital I/O input signal 5	IN5	I
Digital I/O IN6	Digital I/O input signal 6	IN6	I
Digital I/O IN7	Digital I/O input signal 7	IN7	I
Digital I/O OUT0	Digital I/O output signal 0	OUT0	O
Digital I/O OUT1	Digital I/O output signal 1	OUT1	O
Digital I/O OUT2	Digital I/O output signal 2	OUT2	O
Digital I/O OUT3	Digital I/O output signal 3	OUT3	O
Digital I/O OUT4	Digital I/O output signal 4	OUT4	O
Digital I/O OUT5	Digital I/O output signal 5	OUT5	O
Digital I/O OUT6	Digital I/O output signal 6	OUT6	O
Digital I/O OUT7	Digital I/O output signal 7	OUT7	O

*1: OOUT0 to OUT7 and IN0 to IN7 are command names of digital input/output specified by the script file. In this table, signal names for each signal are listed.

*2: Bit 0 to bit 7 signals for script file selection.

In this table, signal names for each signal are listed.

For details of the correspondence of bit 0 to bit 7 signal selection and script file name, see [Script Execution] on the following page.

■ Script execution

Script execution by script signal selection is as a following figure.

1. Select a script file to be executed by using a script selection signal, Digital I/O ST0 to ST7.

2. The selected script file is executed by a START signal input.

(When you input a STEP signal, the commands described on the script file are executed in order.)

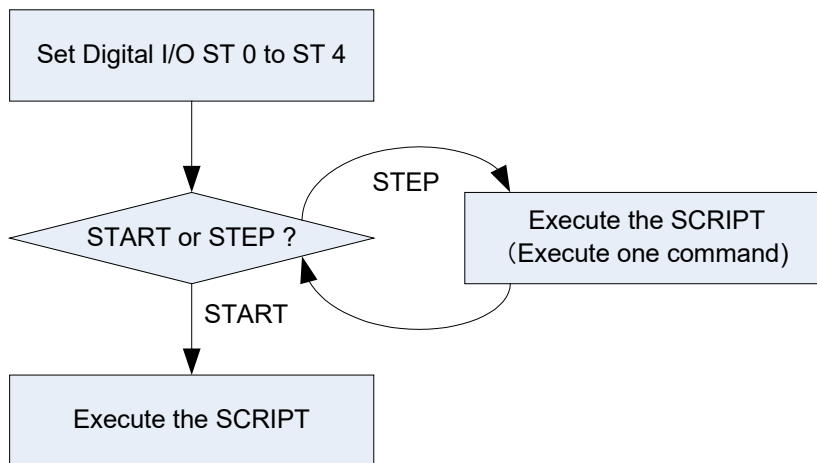

■ Script file name

For details of the Digital I/O ST0 to ST7 output signal and the corresponding script files to be executed, see the table below.

The script file names are fixed.

The script file can be executed when it is placed in the root directory of a dedicated SD card.

XXScript.scp

*1: For XX, you can designate 00 to 255 in 256 ways (XX must be written in two or three digits).

*2: You can name the file by either uppercase or lowercase characters. (not case-sensitive)

ST7	ST6	ST5	ST4	ST3	ST2	ST1	ST0	Script
0	0	0	0	0	0	0	0	00Script.scp
0	0	0	0	0	0	0	1	01Script.scp
0	0	0	0	0	0	1	0	02Script.scp
0	0	0	0	0	0	1	1	03Script.scp
0	0	0	0	0	1	0	0	04Script.scp
.
.
1	1	1	1	1	1	1	1	255Script.scp

6. Answerback Control

First specify arbitrary script file name from control terminal should be execute script after check file existence (Answerback)

It is necessary to connect this equipment, RS-232C and DI/O for this function. And also necessary to prepare control equipment (PC etc.) for answerback control and control software by your own.

In case answerback control execute, it describes ANSWER-BACK in YBO file [MODE].

Below shows description sample when answerback control executes.

In case changing RS-232C configuration with control terminal, please change [RS-232C] configuration as below. Example shows baud rate 9600bps, parity none, stop bit 1bit, data length 8bit.

[M	O	D	E]														
A	N	S	W	E	R	-	B	A	C	K									
[R	S	-	2	3	2	C]											
B	A	U	D	=	9	6	0	0											
B	I	T	=	8															
S	T	O	P	=	1														
P	A	R	T	Y	=	N	O	N	E										
[S	E	T	T	I	N	G]											
[E	N	D]															

6.1. Control Flow

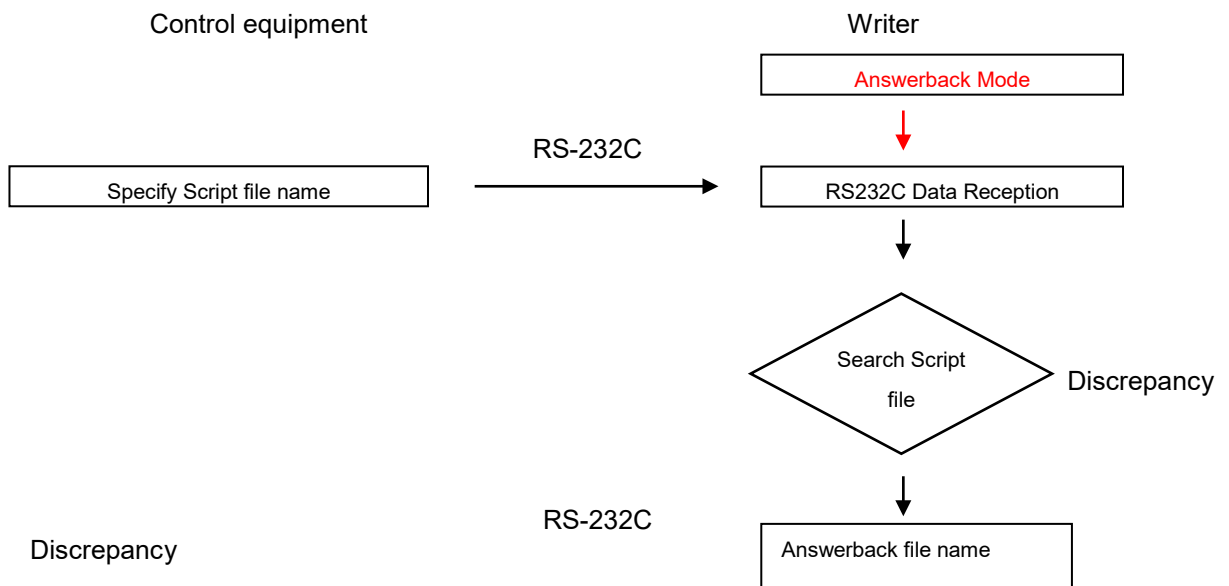

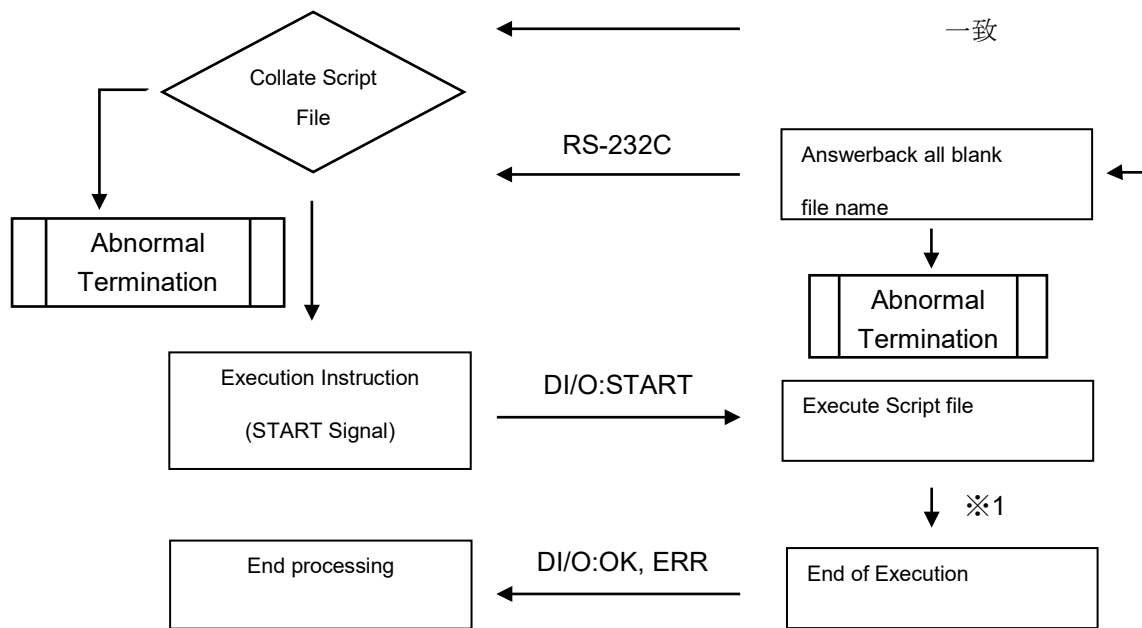

※ 1 In case execute Select Module by Script file, current object file name will transmit via RS-232C.
This function can execute in Answerback mode.

7. List of error codes

Error No.	Error Message	Description	Remedy
1002	NO LICENCE	No licence is found.	You must purchase the licence. “See 2.8.1.ADD LICENCE”
1003	GROUP CODE ERR	Group code is different.	Use parameters suitable for the definition program.
1006	COM ID VER UNEXPECTED	Version of the common part is old.	Make sure to use the latest version.
1007	CM ID VER UNEXPECTED ERR	Version of the specific part is old.	Make sure to use the latest version.
1008	FUNCTION NOT SUPPORT	Function is not supported.	No function is assigned to the specified function.
1009	DEVICE FUNCTION NOT SUPPORT	The device function is not supported.	No function is assigned to the specified function.
1010	HPARAM CONST ERR	Unable to read out hardware parameter.	Contact our support center.
1011	HPARAM WRITE ERR	Unable to write to the hardware parameter.	Contact our support center.
1015	PARAMETER ERR xxxx	Software parameter is corrupted.	Parameters are corrupted. Download the parameters again.
1016	ADDRESS WARNING	Address of write buffer memory and device function area differs from the area of target MCU flash memory.	Make sure the target address area and buffer area are the entire area of the flash writer area.
1017	PROBE LOGIC NO LICENCE	No probe logic licence is found.	Additional probe logic licence is required. See “2.8.1.ADD LICENCE”
1020	S FILE FORMAT ERR	S format error	Object file is corrupted. Check the object file.

1021	HEX FILE FORMAT ERR	HEX format error	Object file is corrupted. Check the object file.
1022	FORMAT ERR (REC TYPE)	Record type error	Object file is corrupted. Check the object file.
1023	FORMAT ERR (ADDRESS)	Address field error	Object file is corrupted. Check the object file.
1024	FORMAT ERR (CHECK SUM)	Checksum error	Object file is corrupted. Check the object file.
1025	FORMAT ERR (CRLF)	CRLF code error	Object file is corrupted. Check the object file.
1026	FORMAT ERR (SIZE)	Record size error	Object file is corrupted. Check the object file.
1027	FORMAT ERR (S5)	S5 record check error	Object file is corrupted. Check the object file.
1028	FORMAT ERR (ASCII)	Binary conversion disabled data error	Object file is corrupted. Check the object file.
1029	DATA FORMAT ERR	Communication data format error	Since the communication error occurs, check the communication path.
102A	CM FORMAT ERR	CM file format error	Definition program may be damaged. Download the definition program.
102B	ADDRESS WARNING	Abnormal setting of an address in the buffer memory area.	Make sure that the object file does not contain any data including addresses outside the area.
102C	FILE NAME SIZE OVER	File name is too long.	Set the file name to 250 characters or less.
102D	RAM FILE SIZE OVER	Ram file data size is too large.	Make sure that downloaded file is less than 256kbyte*. *If firmware is version 17.20 or before, it should be less than 8kbyte.
1037	UPDATE ERR	Fail to update firm and FPGA.	If there is a FWK or HWP file in the root directory of a dedicated SD card, delete the file and retry the update.

1038	UNSUPPORTED	No supporting for PHX4xx update	Set the FPGA version to Ver28.42 or higher.
1039	PHX UPDATE ERR	PHX4xx firmware update error	Rerun the update.
1052	SD READ ERROR	SD card readout error	Format the SD card Set the FPGA version to Ver28.42 or higher.
1053	SD WRITE ERROR	SD card writing error	Format the SD card Set the FPGA version to Ver28.42 or higher.
1054	SD ACCESS ERROR	Access error to the SD card	Format the SD card Set the FPGA version to Ver28.42 or higher.
1066	FULL PATH ERR	File system error of dedicated SD card	The file you attempted to access is corrupted. Format the SD card or delete specified file.
1067	PATH LENGTH ERR	File name is too long.	Set the file name to 250 characters or less.
106B	FILE OPEN ERR	Specified file open error	The file you attempted to access is corrupted. Format the SD card or delete specified file.
106C	FILE NOT OPEN ERR	Specified file is not found	The file you attempted to access is corrupted. Format the SD card or delete specified file.
106D	DOS FILE SIZE ERR	DOS FILE SIZE ERR	File system of the dedicated SD card is corrupted. Format the SD card.
1070	FILE READ ONLY ERR	Write-access is made to a read-only file.	Since the specified file is a read-only file, this error is output. Specify other file or change file attribute of the specified file.
1071	FILE NOT EXIST	File is not found	Since the specified file is not found, this error is output. Specify other file or store the specified file.
1072	FILE NOT EXIST	File is not found.	Since the specified file is not found, this error is output. Specify other file or store the specified file.
1073	FILE EXIST	File already exists.	Since the specified file already exists, the error is output. Specify other file or delete the specified file.

1074	FOLDER NOT EXIST	Folder is not found	Since the specified folder is not found, the error is output. Specify other folder or store the specified file.
1075	FOLDER EXIST	Folder already exists.	Since the specified folder is already exists, the error is output Specify other folder or delete the specified folder.
1076	FILE ENCRYPT ERR	File encryption failed	Specified file encryption has failed. Recreate YIM folder
1077	FILE COMPOSITE ERR	File composite failed	Specified file composite has failed. Re-execute or recreate YIM folder
1078	ENCRYPT SIZE OVER	File size to encrypt is large	Keep the file size to less than 16Mbytes.
1079	ENCRYPT FILE OPEN ERR	Encrypt file is not opened.	Specified encrypt file is corrupted. Recreate YIM folder.
107A	OBJ FILE NOT SAVE	Inaccessible to the object file.	Specified object file cannot be read.
1090	YSM CHECK ERR	YSM checksum error	Check the sum data of the YSM or sum value of the buffer.
1091	YSM CHECK ERR	YSM check buffer error	Check the buffer data of the YSM or data of the buffer.
1092	YSM FILE FORMAT ERR	YSM file format error	Check the YSM file format.
1093	YSM NOT FOUND	YSM file exists	Put the YSM file into the YIM folder.
10A0	ETHER SEND CUT ERR	Line is cut-off when sending ETHER	Check the ETHERNET line.
10A1	ETHER SEND TIMEOUT	Time-out occurs when sending ETHER	Check the ETHERNET line.
10A2	ETHER RECV CUT ERR	Line is cut-off when receiving ETHER.	Check the ETHERNET line.

10A3	ETHER RECV TIMEOUT	Time-out occurs when receiving ETHER.	Check the ETHERNET line.
10A4	ETHER ERR	ETHER communication cannot be made	Check the ETHERNET line.
10A5	NEXT COMMAND NOT RECV	Abnormal ETHER connection.	Check the ETHERNET line.
10B0	COM OUT ERR	RS232C send error	Check RS232C or the connection of the barcode reader.
10B1	COM IN ERR	RS232C reception error	Check RS232C or the connection of the barcode reader.
10C0	DEVICE SEND TIMEOUT xx	Target communication send time-out	Error occurs in the communication with the target.
10C1	DEVICE RECV TIMEOUT xx	Target communication receive time-out	Error occurs in the communication with the target.
10C2	DEVICE OVERRUN ERR xx	Target communication receive over-run	Error occurs in the communication with the target.
10C3	DEVICE FRAMOUTG ERR xx	Target communication framing error	Error occurs in the communication with the target.
10C4	DEVICE PARITY ERR xx	Target communication parity error	Error occurs in the communication with the target.
10D0	CSB NOT FOUND	CSB file is not found.	Store the CSB file.
10D1	MORE 2 CSB FILES	Two or more CSB files exist.	Delete the CSB files so that one CSB file exists.
10D2	CSB FILE FORMAT ERR xxxx	CSB file format error	Check the CSB file format.
10D3	FUNCTION DATA ERR	CSB or YMN function parameter error	Check the CSB and YMN function parameters.

10D4	YMN FILE FORMAT ERR	YMN file format error	Check the YMN file format.
10D5	YMN NOT REGIST	YMN file is not registered.	Check the YMN file is stored or the YMN file name is correct.
10E2	BAUDRATE SET ERR	No configurable baud rate.	Check the parameter file is correct.
10E3	PROBE NOT CONNECT	Probe cannot be connected normally.	Check the probe connection after powering off the main body.
1100	DEVICE CLEN ERR	Over-current detection	Device may be short-circuited with the target. Check the connection with the target.
1101	TVCC TOO LOW	Target voltage is low.	Target power needs to be connected to the TVCC.
1108	DEVICE INITIALIZE COM ERR	Initial communication error	Target may not be transited to the operation mode. Check the connection with the target.
1109	DEVICE ERR xx	Device error	<p>Check whether it is possible to access the target device if it is not possible due to security reasons, etc.</p> <p>xx(※) shows the executing location of the device function.</p> <p>0x01 : Erasure process execution error</p> <p>0x02 : Blank check error</p> <p>0x03 : Writing process execution error</p> <p>0x04 : Verification error</p> <p>0x05 : Copy processing error</p> <p>※ The errors above may differ depending on the definition program. See your definition program manual.</p>
110A	DEVICE SCI SUM ERR xx	SCI communication sum error	Check the communication with the target.
110B	DEVICE ILLEGAL REPLY xx	Unexpected data is received via SCI communication	Check the communication with the target.
110C	SUM VERIFY ERR xx	Sum verify error	Check the communication with the target.

110E	BTP NOT FOUND	BTP file is not found.	Store the BTP file
110F	MORE 2 BTP FILES	Two or more BTP files exist.	Delete BTP so that only one BTP exists.
1110	BTP FORMAT ERR	BTP file format error	Check the BTP file format.
1111	KEY NOT FOUND	No KEY file is found.	Store the KEY file.
1112	MORE 2 KEY FILES	Two or more KEY files exist.	Delete KEY so that only one KEY exists.
1113	KEY FORMAT ERR	KEY file format error	Check the KEY file format.
1120- 113F	xxxxx	Error occurs in the definition of the specific part.	See the manual for definition.
1140	PHX400 ADAPTER CONNECT ERR	Error in communication between NETIMPRESS avant and PHX400.	Check the connection between NETIMPRESS avant and PHX400. It is necessary to connect the target power supply to TVCC. Check the input voltage to the target microcomputer is correct.
1141	PHX400 UART COM ERR	Error in communication between NETIMPRESS avant and PHX400.	Check the connection between NETIMPRESS avant and PHX400.
1150	YIM MAX	The number of YIM folder reached an upper limit (65535).	Remove unnecessary YIM folder from the SD card.
1151	YIM PROTECTED	YIM folder is protected.	Cancel the protection.
1160	YLC NOT FOUND	YLC file is not found.	Store the YLC file.
1161	MORE 2 YLC FILES	Two or more YLC files exist.	Only one YLC file can exist, so delete the rest.

1162	YLC FORMAT ERR	YLC file format error	Check the YLC file format.
1163	ATTOM ERR	ETHER Communication error	The communication between NETIMPRESS avant and the PC is disconnected or communication is not possible. Check the status of the ETHER connection.
1164	LICENCE 100 OVER	The number of registered licenses has reached the upper limit.	Contact our support center.
1170	YCM FORMAT ERR/	YCM file format error	Check the YCM file format.
1170	FILE SIZEGET ERR	YCM file format error	Check the YCM file format.
1180	YIM NOT REGIST	YIM undefined error	Set the YIM folder.
1181	CM NOT REGIST	Definition program undefined error	Download the definition program.
1182	BUF NOT REGIST	Buffer memory undefined error	Keep a sufficient free area size of dedicated SD card and start up the programmer.
1190	FILE OPEN ERR	File open error	A failure in file access has been detected. Since the specified file may be corrupted, delete the file and reload it.
1191	FILE CLOSE ERR	File close error	
1192	FILE READ ERR	File read error	
1193	FILE WRITE ERR	File write error	
1194	FILE SEEK ERR	File seek error	
1195	FILE SYNC ERR	File synchronization error	

1196	FILE RENAME ERR	File rename error	
1197	FILE DIR ERR	File directory open error	
1198	FILE SEARCH ERR	File search error	
1199	FILE CD ERR	File change directory error	
119A	FILE MKFILE ERR	Making file error	
119B	FILE MKDIR ERR	File directory making error	
119C	FILE RMFILE ERR	Remove file error	
119D	FILE RMDIR ERR	Remove directory error	
119E	FILE COPY ERR	File copy error	
119F	FILE XCOPY ERR	File directory copy error	
1200	DEVICE FUNCTION ERR	Device function interrupted error	
1A00	SCRIPT FILE NOT (START)	Script file error: No (START) line on the executing script file	Check the script file.
1A01	SCRIPT FILE ERR LOUTE XXXX	Script file error: There are unspecified descriptions on the line No. XXXX of the executing script file.	Check the script file.
1A02	SCRIPT FILE FORMAT ERR	Script file error:No (START) line on the executing script file	Check the script file.

1A03	SCRIPT EMPTY	Script file error:No commands to execute on the (START) to (END) of the executing script file.	Check the script file.
1A04	SCRIPT DI TIMEOUT	Error while executing the script file: Cannot detect the on/off of input signal which is specified during time-out time on the INPUT line of the script.	Check the line of script file on which the error occurred, and your environments.
1A05	SCRIPT FILE NOT FOUND	Error for the script file search: Cannot find the script file specified by barcode or digital input.	Make sure that the information specified by the barcode or digital input conforms to a target script file.
1A06	DIO CLEN ERR	Overcurrent is detected when outputting digital I/O	Check the wire connection of digital I/O of programmer and your DI/O unit.
1A10	RTC DATA FORMAT ERR	Abnormal setting value is detected in setting of NETIMPRESS avant built-in RTC.	Check that the set value is within the specification time.
1A14	LOG FILE OVER	The number of log file has reached the upper limit.	Remove the log files.
1A16	LOG FILE NOT OPEN ERR	Cannot open the logfile	The specified log file may be corrupted. Delete the specified log file.
1A19	YRM FILE OVER	The number of YRM file has reached the upper limit.	Select another YIM folder and clear the YRM file.
1A20	BCR RECV TIMEOUT	Time-out occurs when receiving the barcode	Check the SUFFIX setting of the barcode reader. If SUFFIX is specified by YBO file, check the characters specified for SUFFIX, and your barcode data.
1A21	BCR DATA FORMAT ERR	Format of the barcode data is not correct	Check the created barcode data. Check that the designation of barcode option file (YBO) is correct.
1A23	BCR YBOFILE_FORMAT_ERR	Format error of the barcode option file (YBO)	Check the YBO file.
1A24	MORE 2 YBO FILES	More than one barcode option files (YBO) are existed.	Make sure to place only one YBO file in the root directory of the dedicated SD card.

1A25	BCR RECV OVER	More than one barcode option files (YBO) are existed.	Make sure to place only one YBO file in the root directory of the dedicated SD card.
1A27	BCR CLEN ERR	Overcurrent occurs when connecting the barcode	Check the condition of the barcode device connected to NETIMPRESS avant
1A28	YBO FILE MODE ERR	Mode setting for YBO is not correct	Check the contents of YBO file.
1A29	BCR ILLEGAL DATA (1:NULL)	Error during analysis of the received barcode	Check the created barcode data and the barcode option file (YBO) are specified correctly.
1A2A	BCR ILLEGAL DATA (START-SUFFIX)	Cannot search for files because START to the end of the barcode is more than 249.	Check the created barcode data.
1A2B	BCR ILLEGAL DATA(START)	No character to the START of the barcode.	Check the created barcode data.
1A2B	BCR ILLEGAL DATA(END)	No character to the END of the barcode.	Check the created barcode data.
1A2C	BCR ILLEGAL DATA(SUFFIX)	Cannot search for files because the barcode contains more than 249 characters.	Check the created barcode data.
1A30	PROBE CONNECT ERR	Probe (PHX4xx) connection error	Check the connection between the PHX4xx and NETIMPRESS avant.
1A31	PROBE UNCONNECT CH1	Probe (PHX4xx) connection error	Check the "PROBE SELECT" signal matches the connection of the PHX4xx to NETIMPRESS avant.
1A32	PROBE UNCONNECT CH2	Probe (PHX4xx) connection error	Check the "PROBE SELECT" signal matches the connection of the PHX4xx to NETIMPRESS avant.
1A33	PROBE SELECT NO SIGNAL	Probe (PHX4xx) connection error	Check the connection between the PHX4xx and NETIMPRESS avant.

8. Contact

For inquiry about the specification of NETIMPRESS avant, please contact our support center. For inquiry about the price information or lead time, please contact our sales or your local distributors.

Contact

NETIMPRESS Support Center

E-mail : support-impress@dts-insight.co.jp

7th Floor Shinjuku MIDWEST BLDG. 4-30-3 Yoyogi, Shibuya-ku, Tokyo, 151-0053, Japan



NETIMPRESS avant OPERATION MANUAL

DTS INSIGHT CORPORATION

URL: https://www.dts-insight.co.jp/en/support/support_netimpress_avac/

6th Edition published on December 29th, 2022.

© 2022 DTS INSIGHT CORPORATION. All rights reserved.